

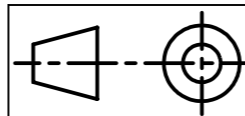



Date	2026-01-05
	10:47:04



G	Sheet 1-7	2026-01-05 10:47:04	20704 SAUNA CABIN 25(44)	A3
		Date		VIEW 1



Date	2026-01-05
	10:47:04

 				2026-01-05		20704 SAUNA CABIN 25(44)	A3
	G	Sheet 2-7	Date				VIEW 2

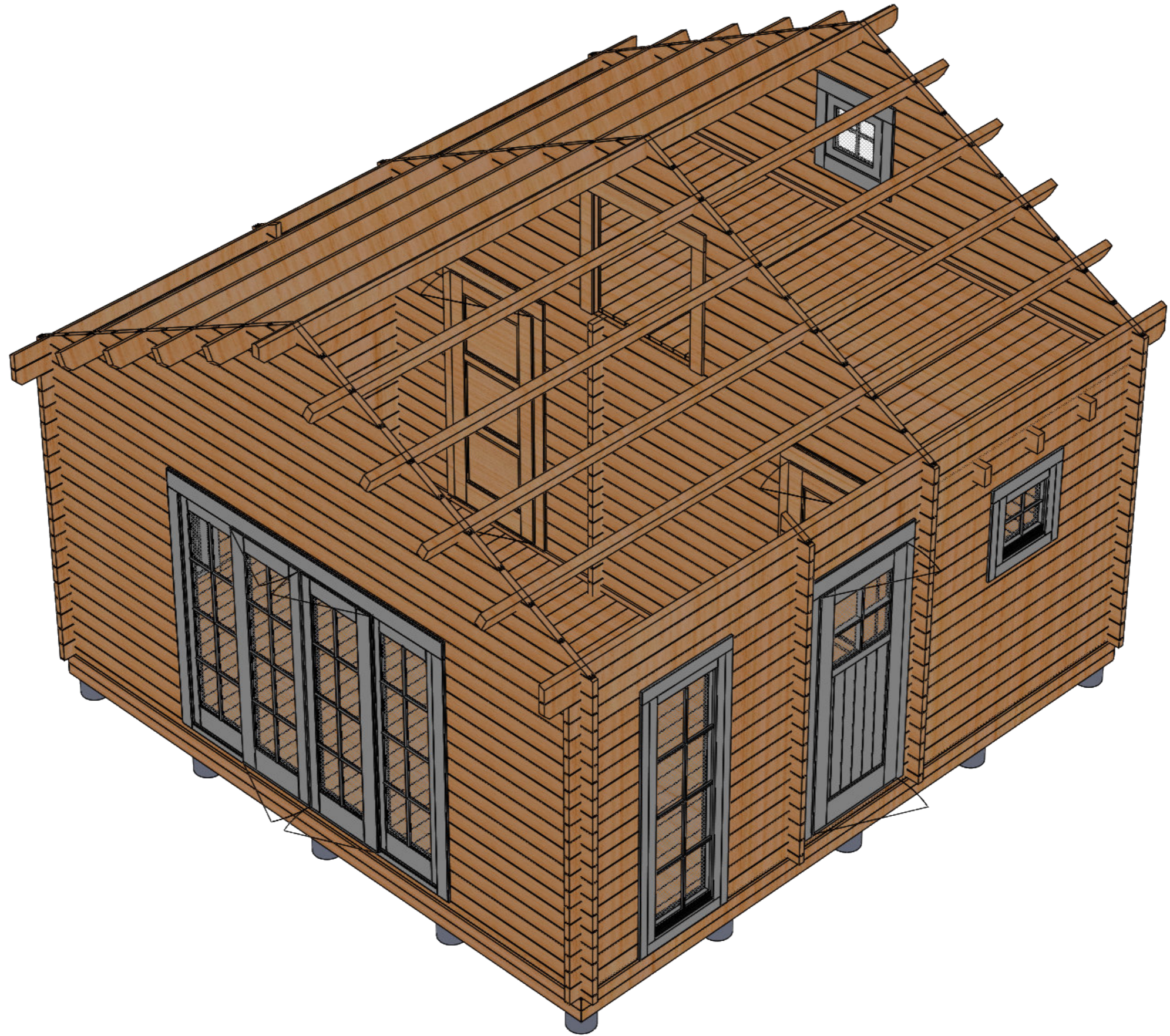

Date	2026-01-05
	10:47:04

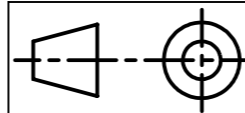

G	Sheet 3-7	Date	2026-01-05	10:47:04	20704 SAUNA CABIN 25(44)	A3
					VIEW 3	

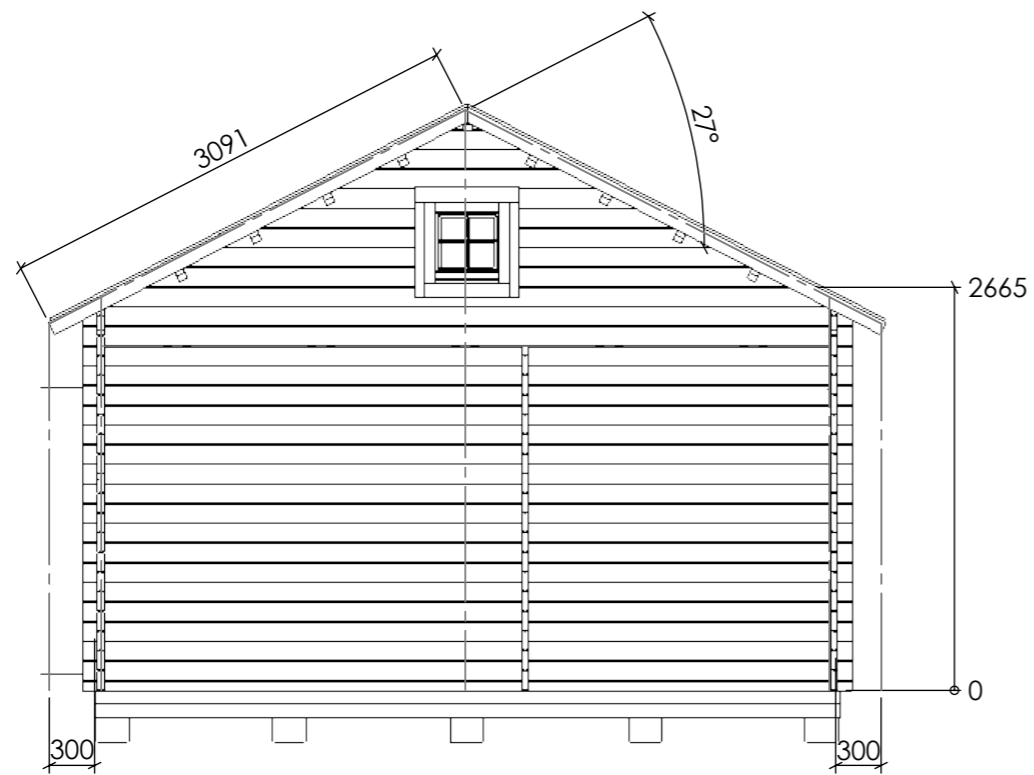
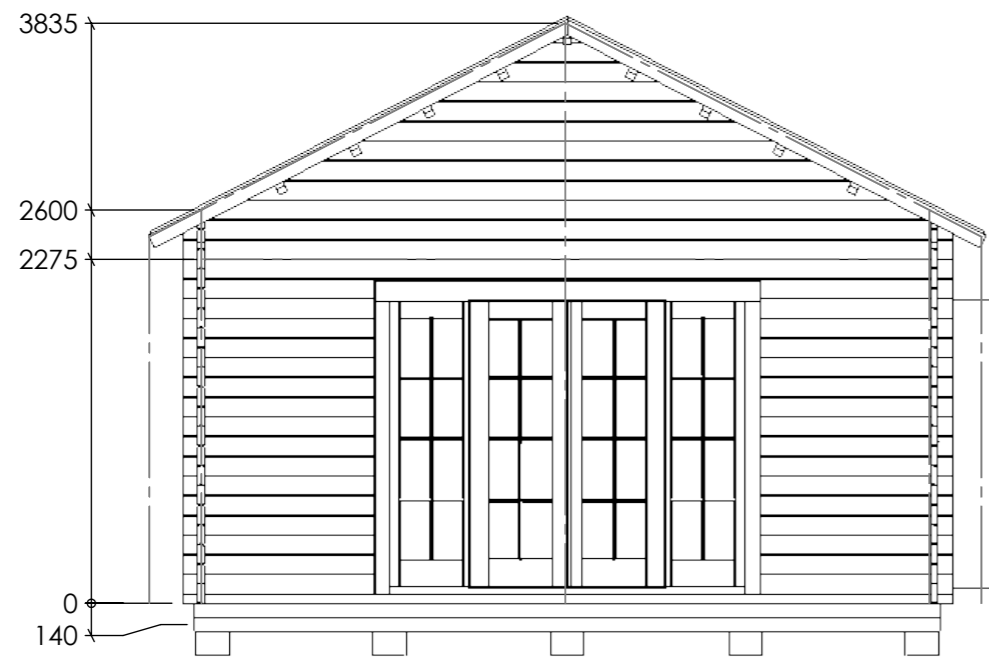

Date
2026-01-05
10:47:04

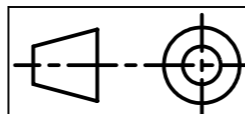

G

Sheet 4-7

2026-01-05
10:47:04

Date

20704 SAUNA CABIN 25(44)

Facades

A3

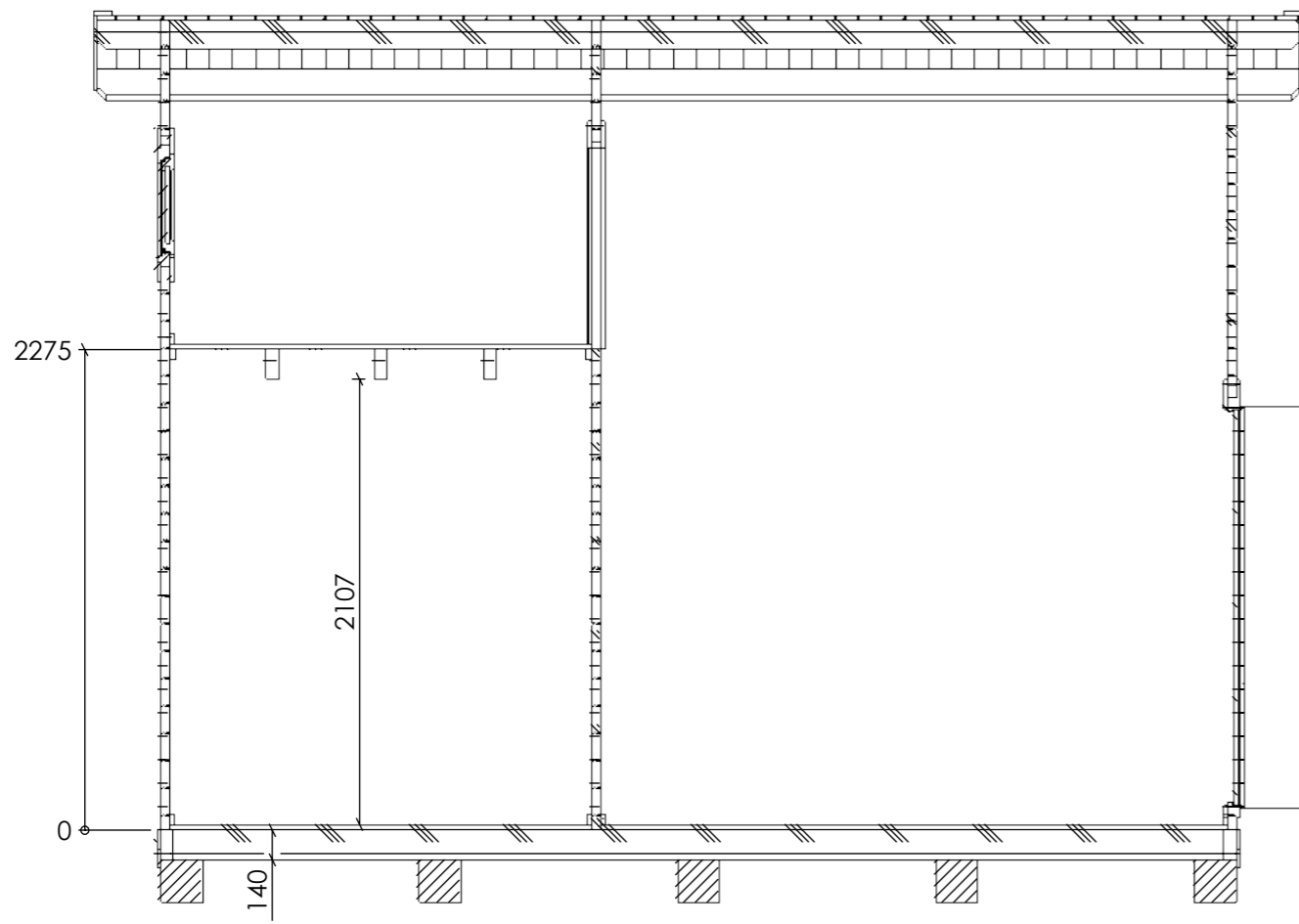

Section A

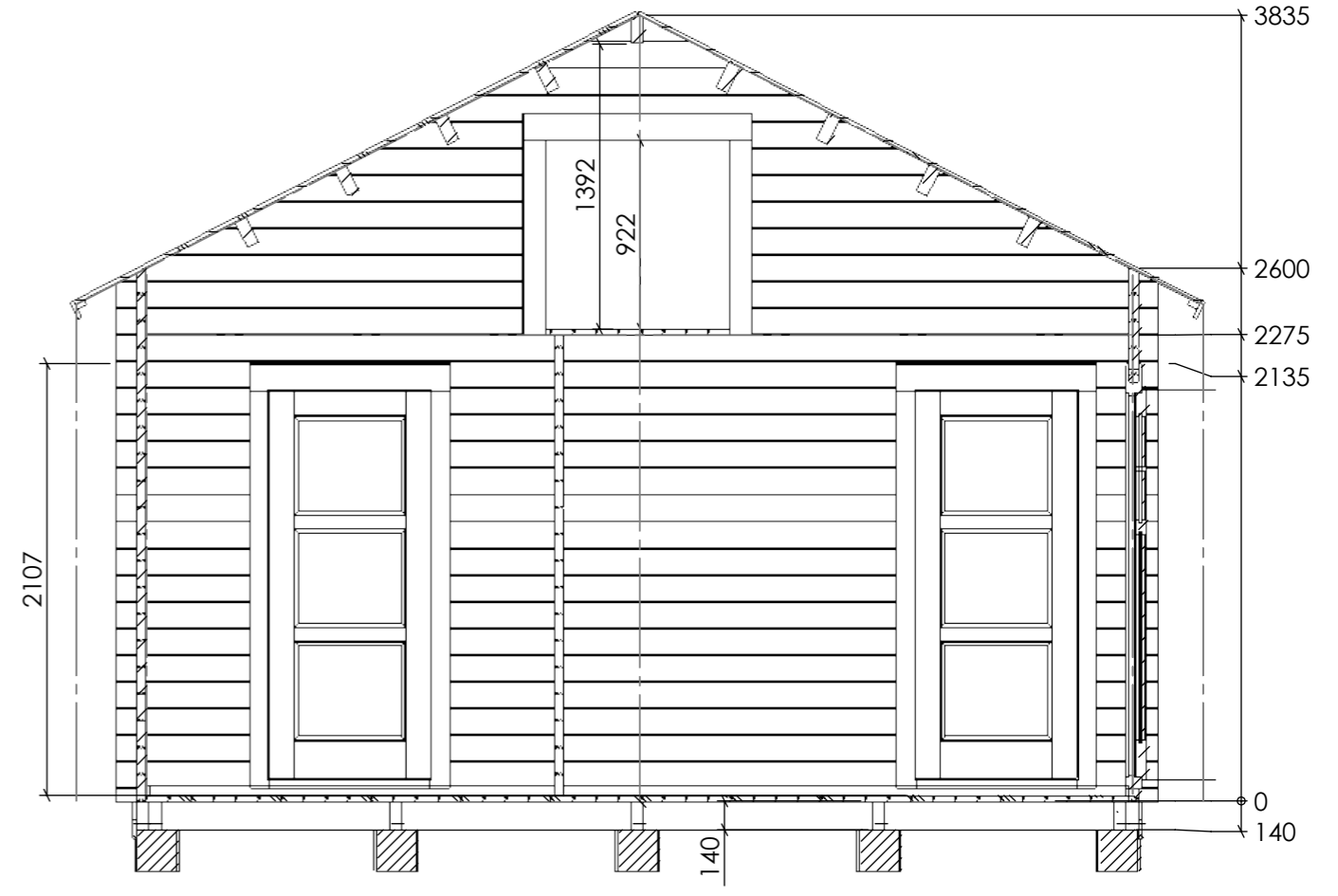

Section B

Date	2026-01-05
	10:47:04

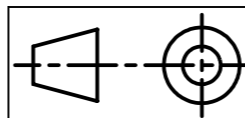

G	Sheet 5-7	2026-01-05	10:47:04	20704 SAUNA CABIN 25(44)	A3
		Date			Section

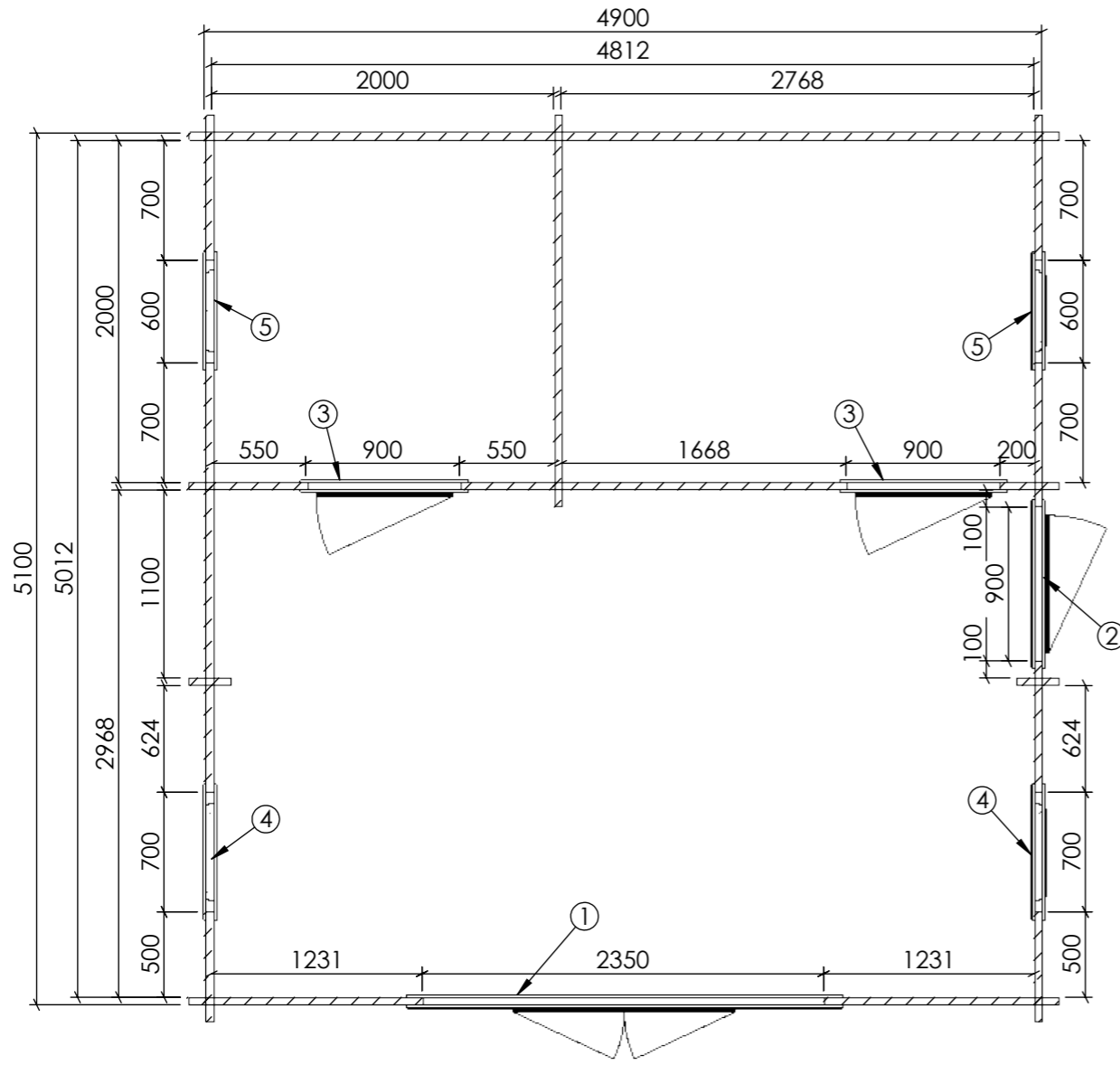

Plan A

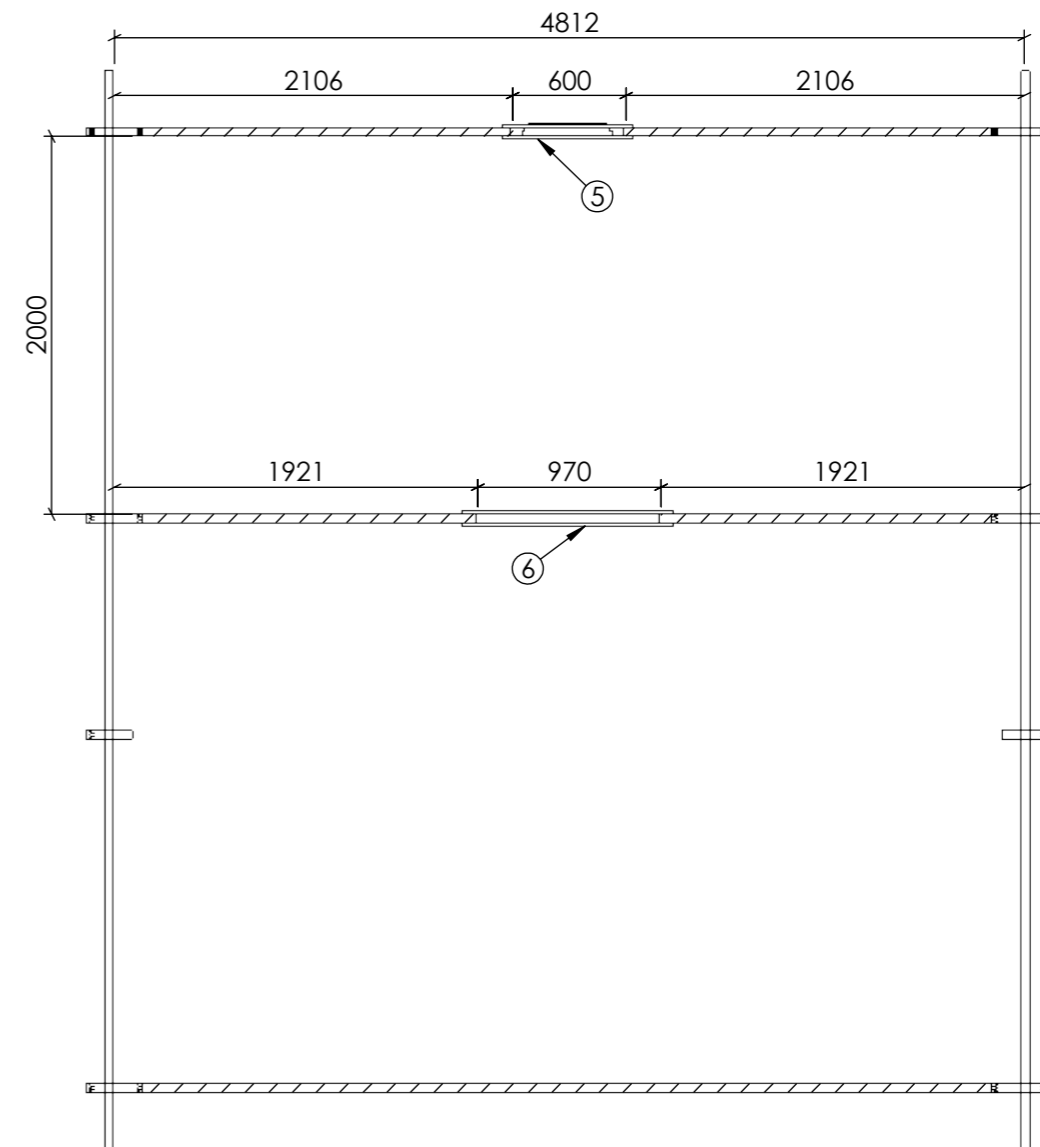

Plan B

ITEM NO.	Element	QTY.
1	Door 1980x2330	1
2	Door 1980x880	1
3	Door 1980x880	2
4	Window 1980x680	2
5	Window 580x580	3
6	Frame 950x900(inside)	1

Date	2026-01-05 10:47:04
	6.12

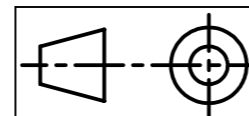

G	Sheet 6-7	2026-01-05 10:47:04	Date	20704 SAUNA CABIN 25(44)	A3
				Plan	

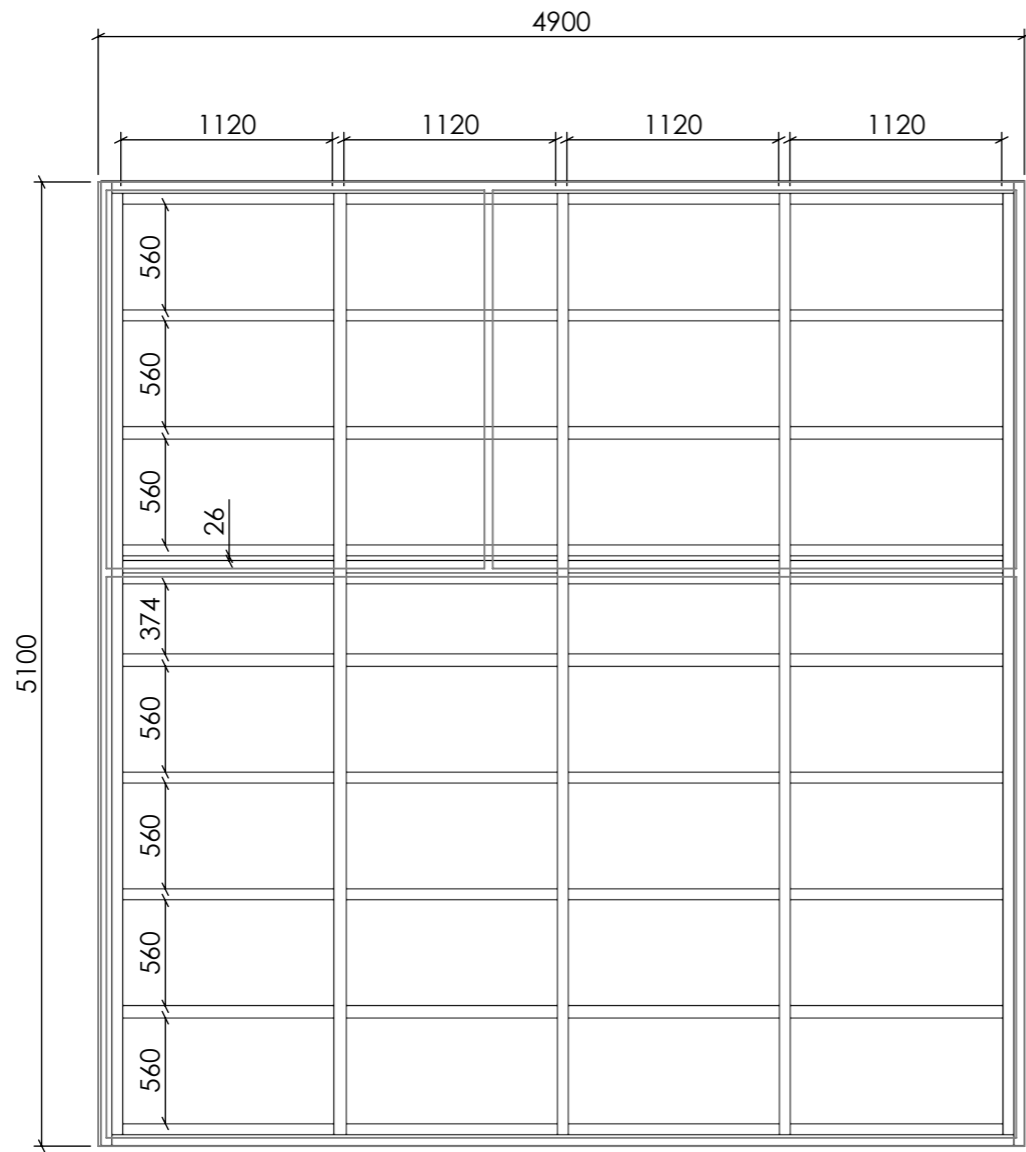

FLOOR BEAM 60X140

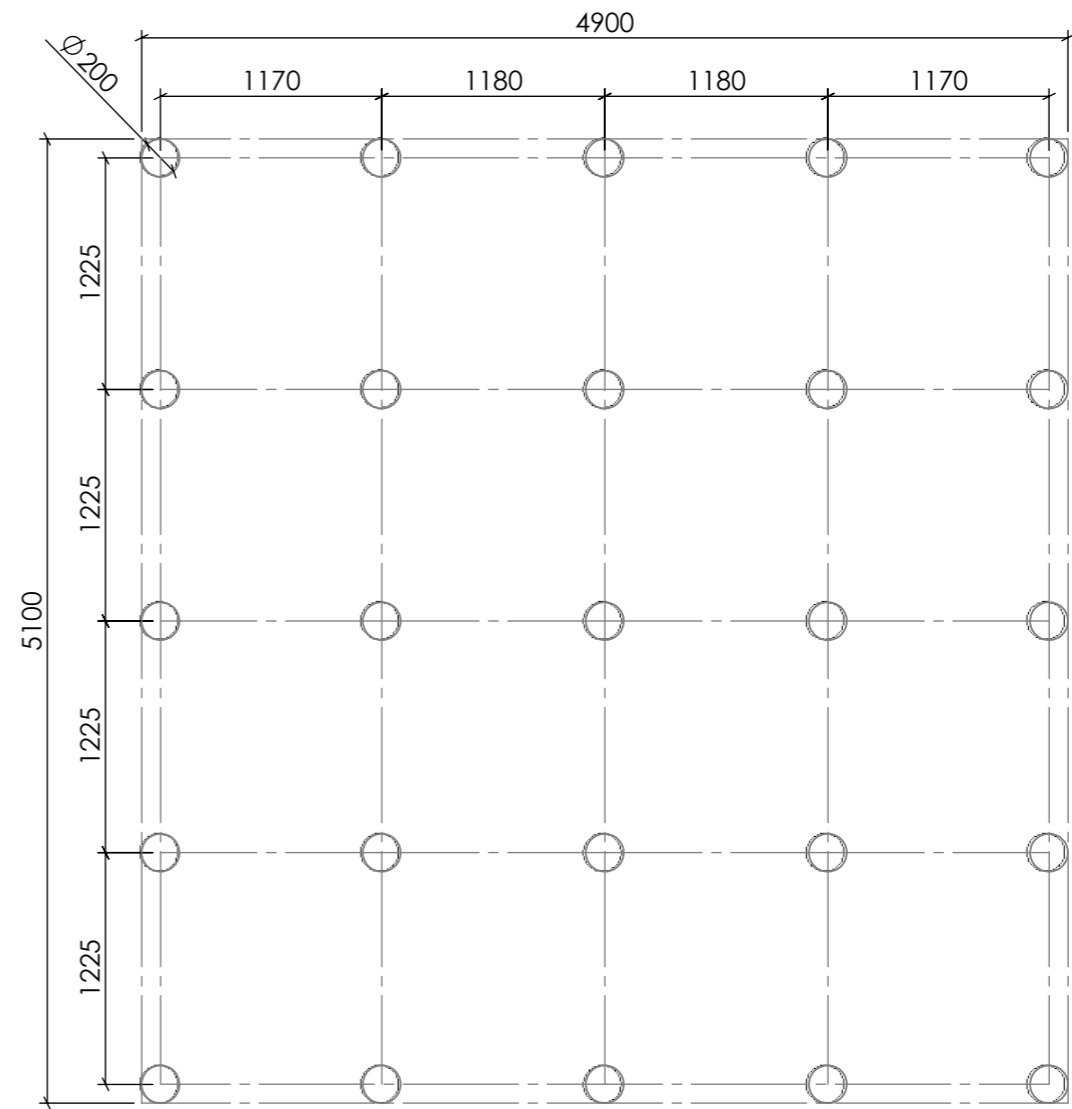

POLE PLAN

Date	2026-01-05
	10:47:04

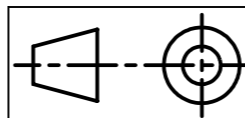

G	Sheet 7-7
---	-----------

2026-01-05	10:47:04
Date	

20704 SAUNA CABIN 25(44)

A3
POLE PLAN