





Date	2026-01-09
	15:24:53

 				2026-01-09		20704 SAUNA CABIN 25(44)	A3
	G	Sheet 1-7	Date				VIEW 1



Date	2026-01-09
	15:24:53

 				2026-01-09		20704 SAUNA CABIN 25(44)	A3
	G	Sheet 2-7	Date				VIEW 2

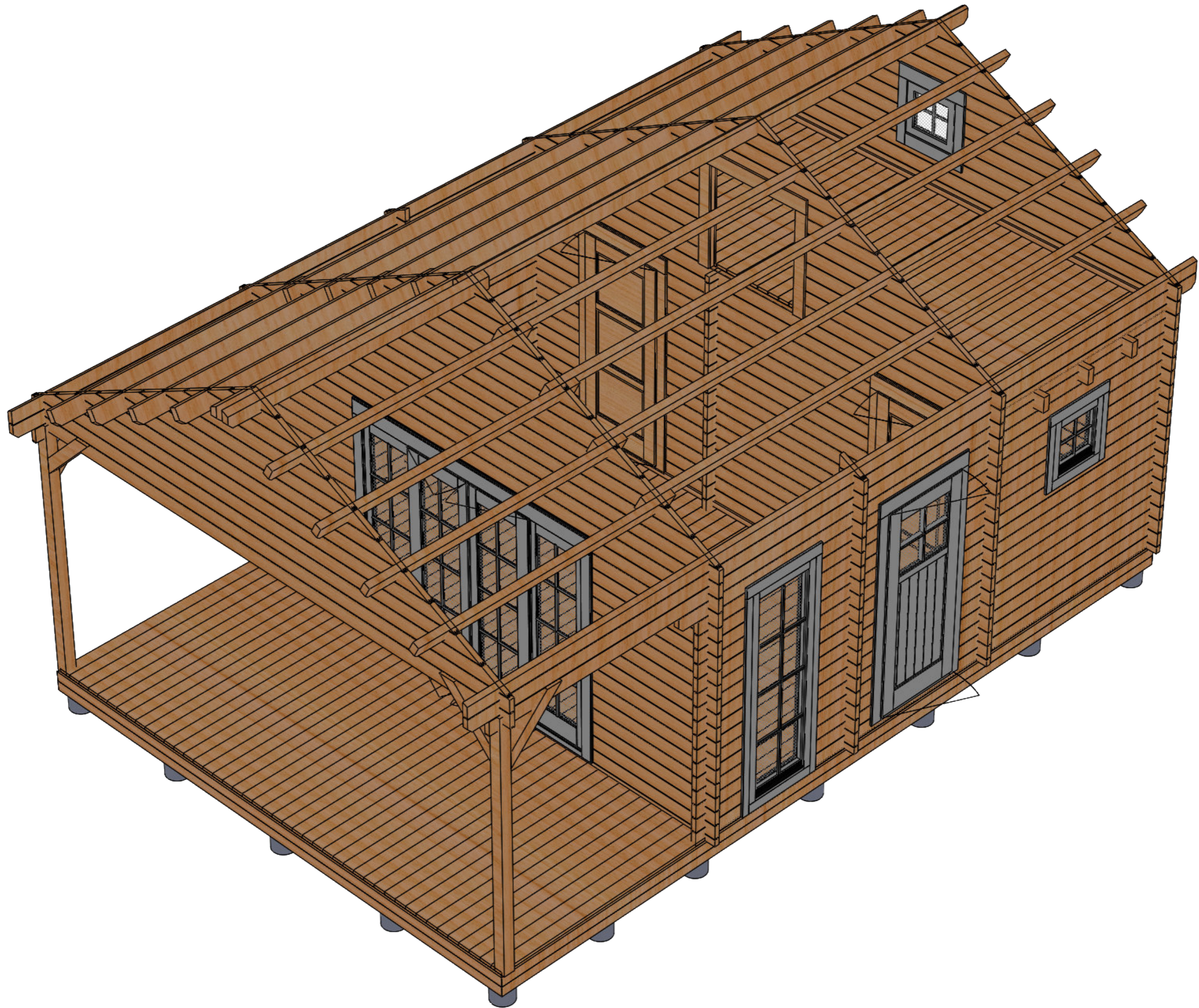

Date	2026-01-09
	15:24:53

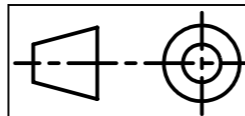

G	Sheet 3-7	2026-01-09 15:24:53	20704 SAUNA CABIN 25(44)	A3
		Date		VIEW 3

2

1

A

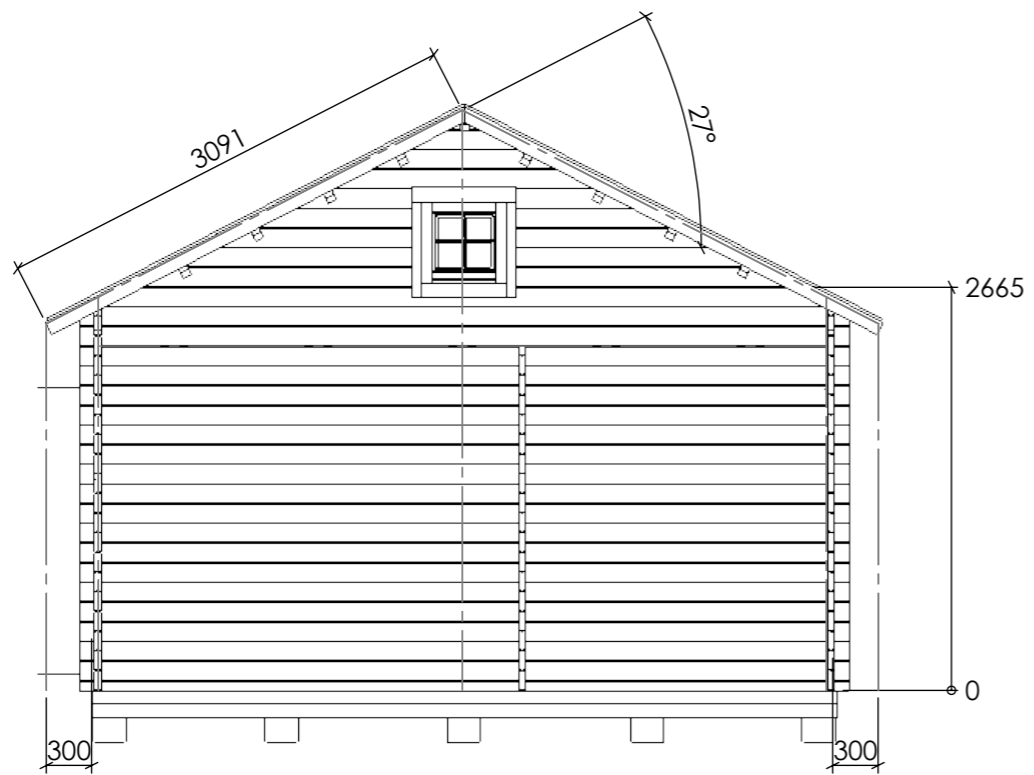

Date
2026-01-09
15:24:53

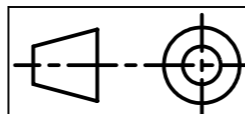

G

Sheet 4-7

2026-01-09
15:24:53

Date

20704 SAUNA CABIN 25(44)

Facades

A3

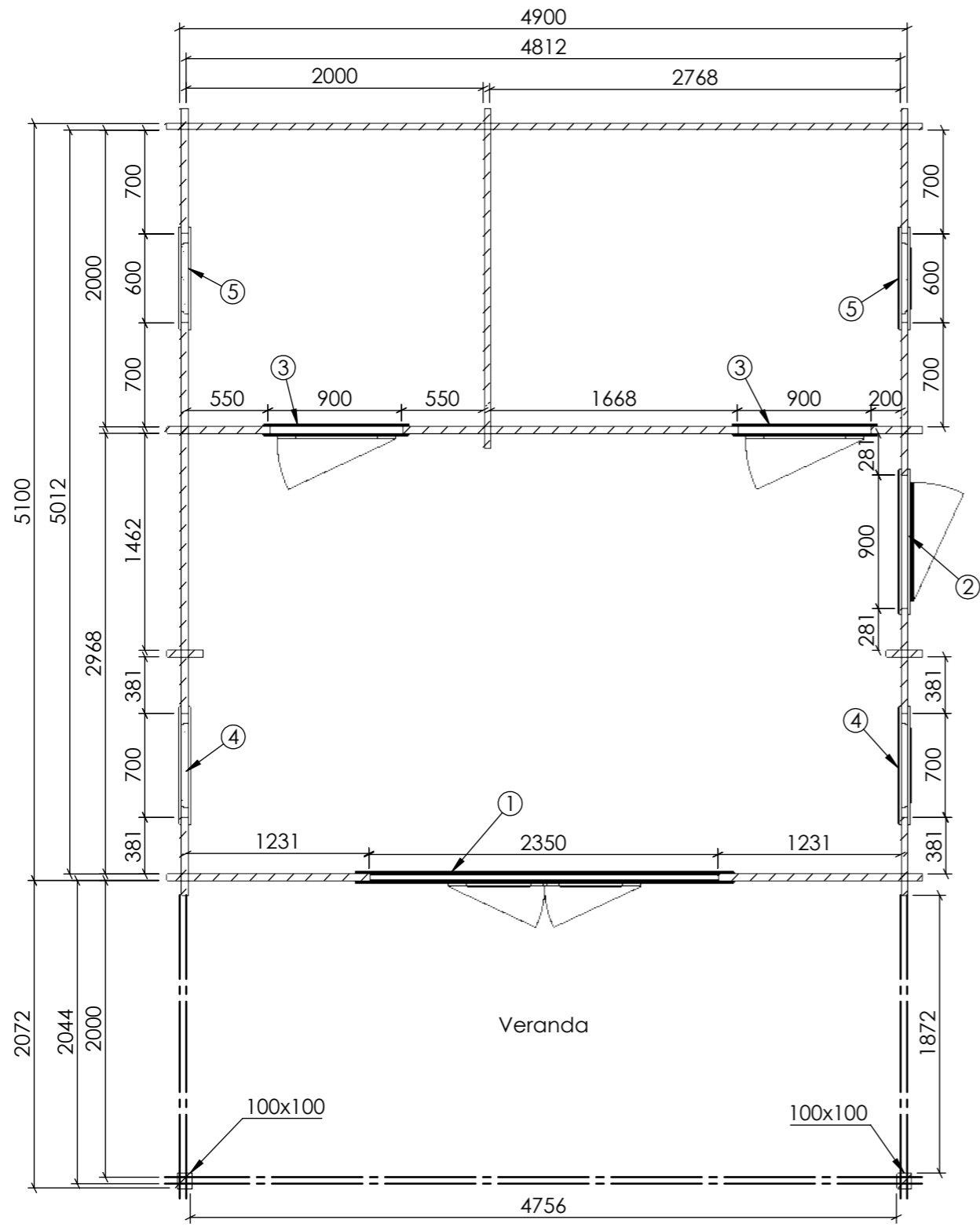

Plan A

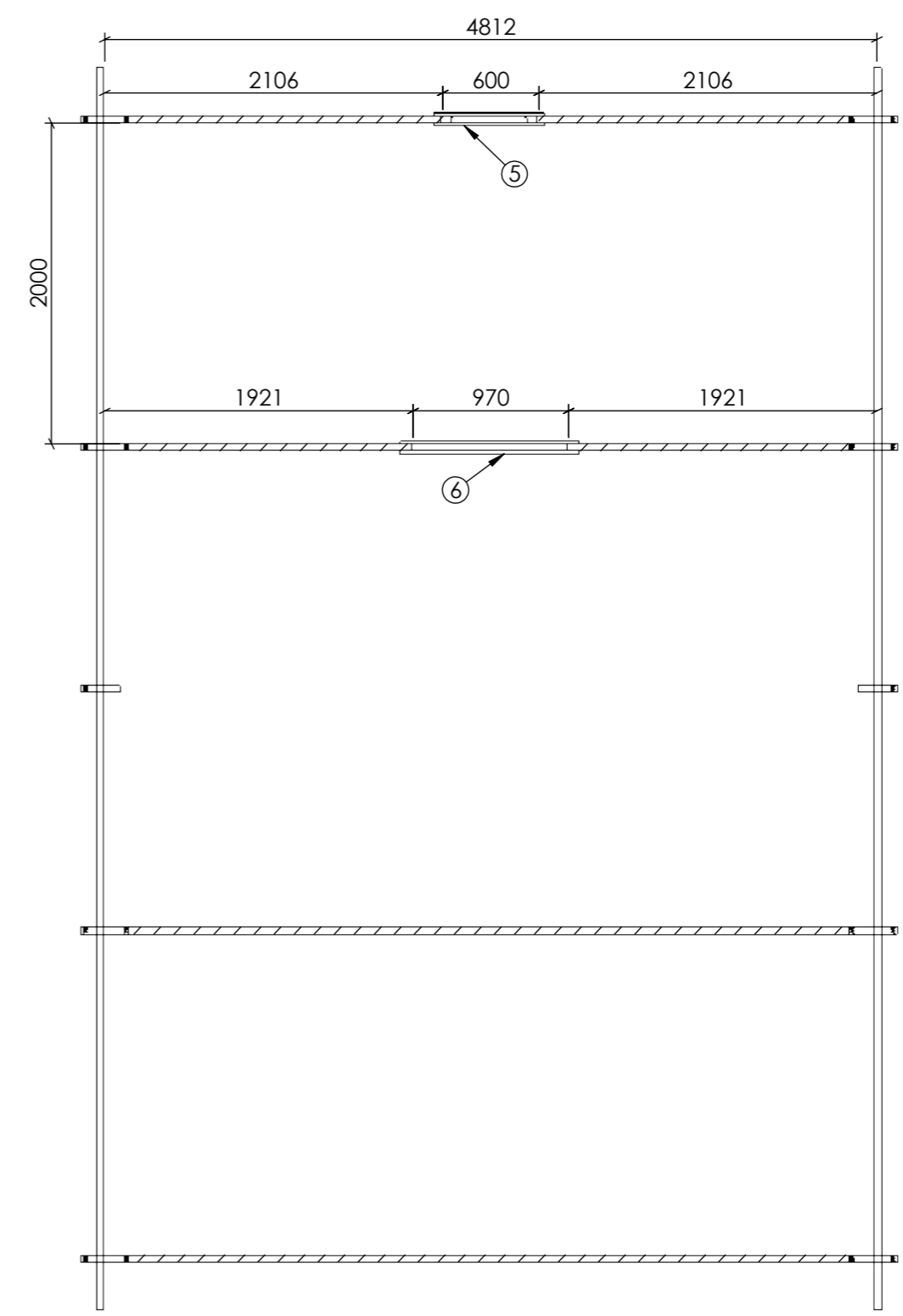

Plan B

ITEM NO.	Element	QTY.
1	Door 1980x2330	1
2	Door 1980x880	1
3	Door 1980x880	2
4	Window 1980x680	2
5	Window 580x580	3
6	Frame 950x900(inside)	1

Date	2026-01-09 15:24:53
7.5	

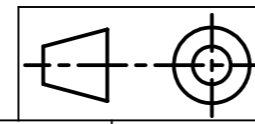

G	Sheet 6-7	2026-01-09 15:24:53	Date	20704 SAUNA CABIN 25(44)	A3
				Plan	

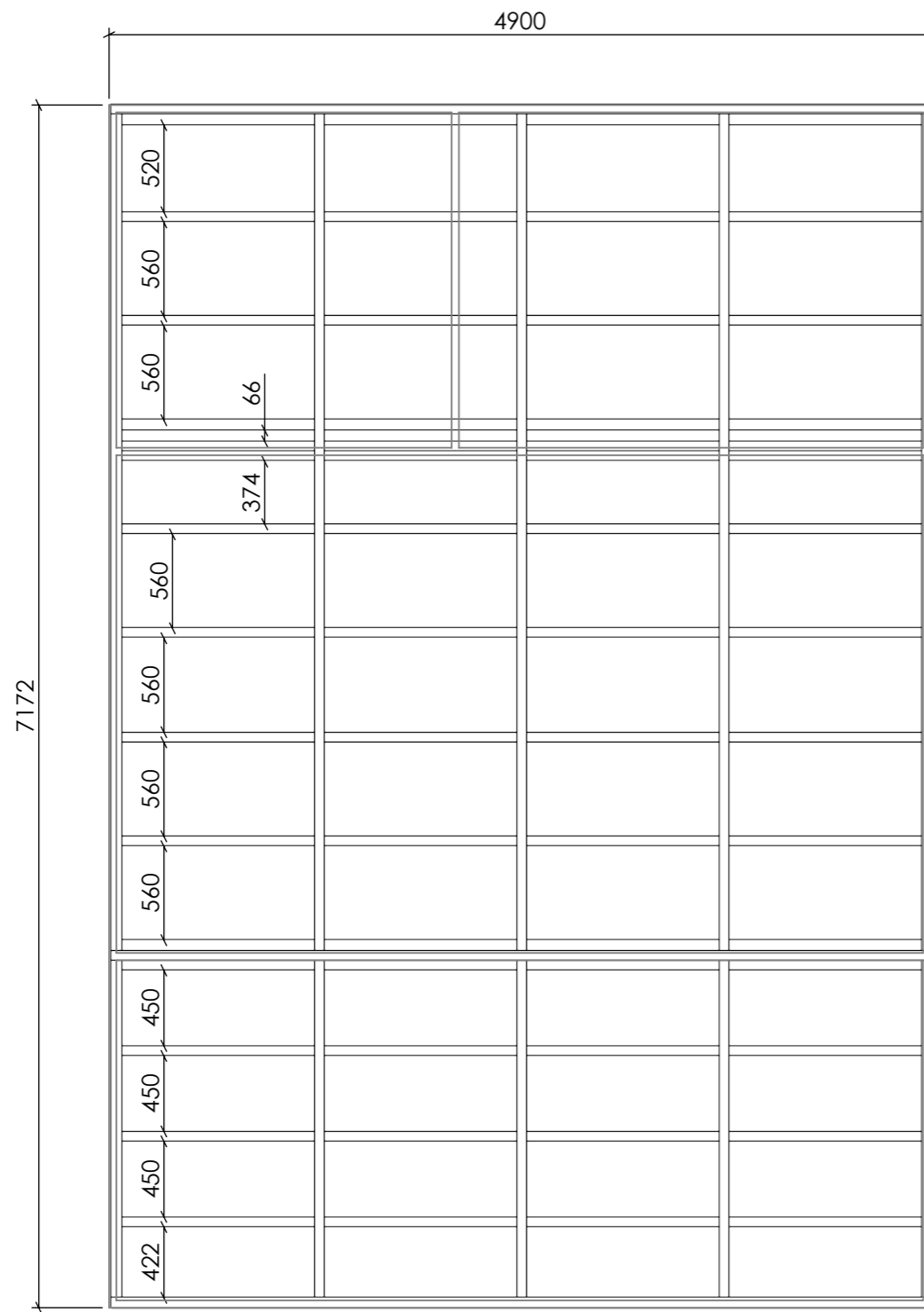

FLOOR BEAM 60X140

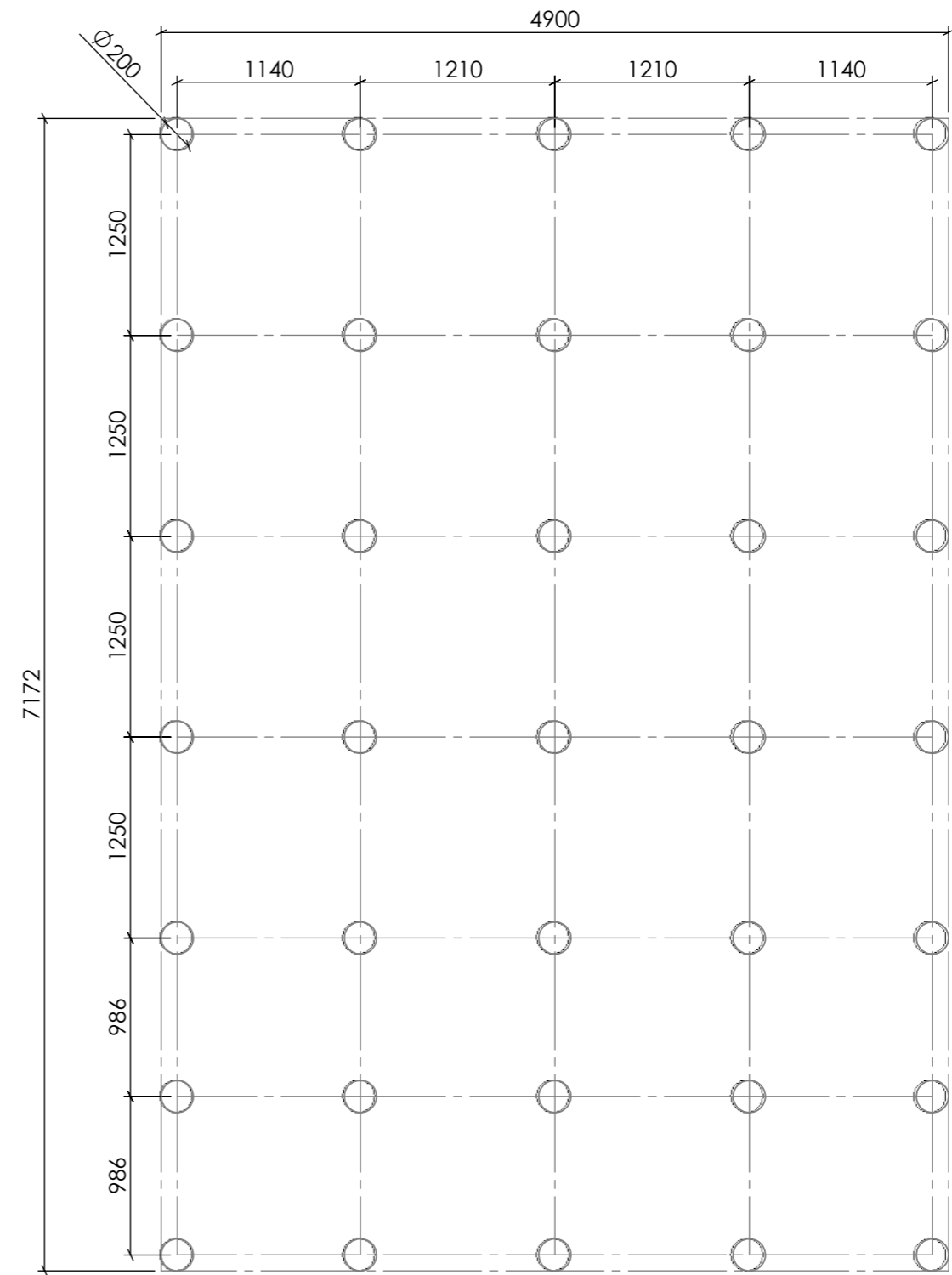

POLE PLAN

Date	2026-01-09
	15:24:53

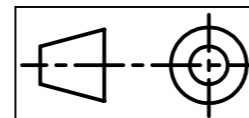

G	Sheet 7-7
---	-----------

2026-01-09	15:24:53
Date	

20704 SAUNA CABIN 25(44)

A3
POLE PLAN