

2

1

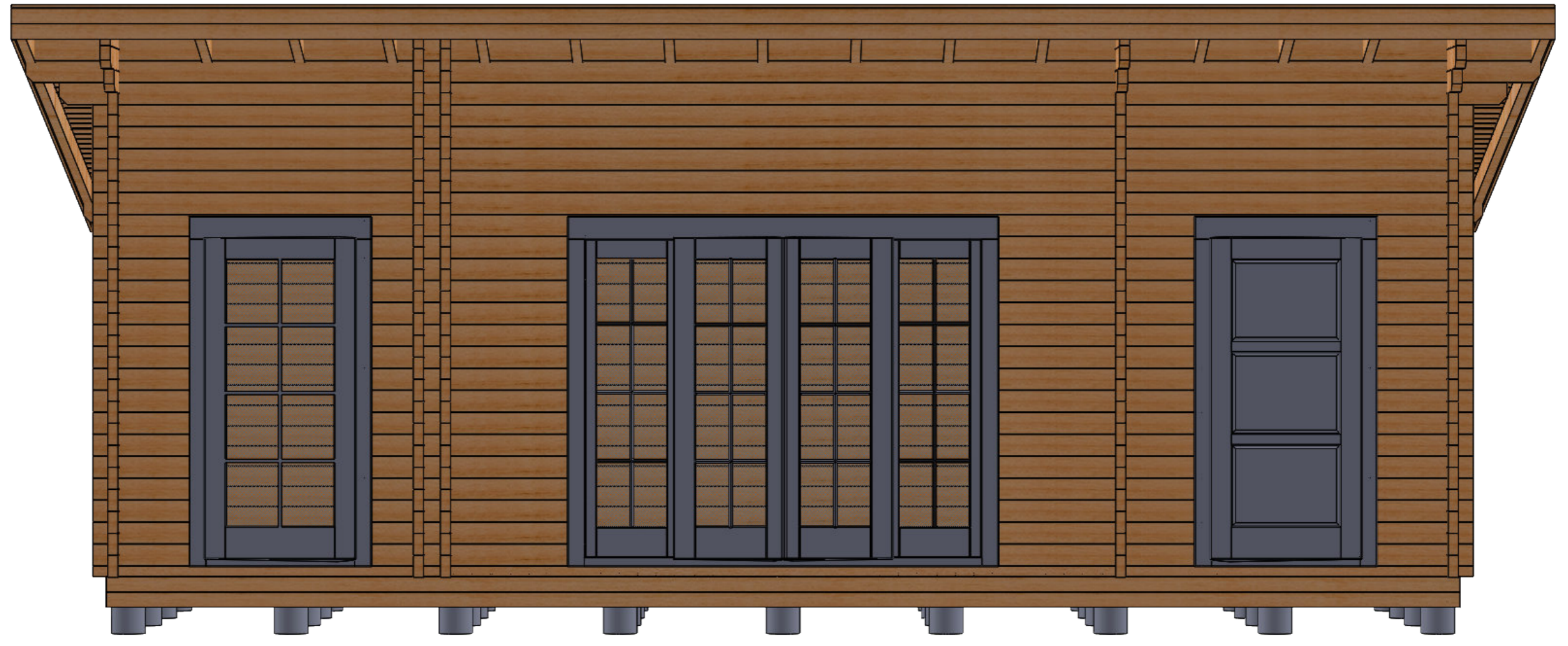

| | |
|------|------------|
| Date | 2026-03-19 |
| | 10:20:54 |

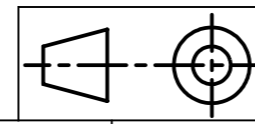

| | | | | | |
|---|-----------|------------------------|------|------------------|----|
| G | Sheet 1-9 | 2026-03-19 10:20:54 | Date | 20719 NB8030(60) | A3 |
| | | | | Sheet1 | |



2

1

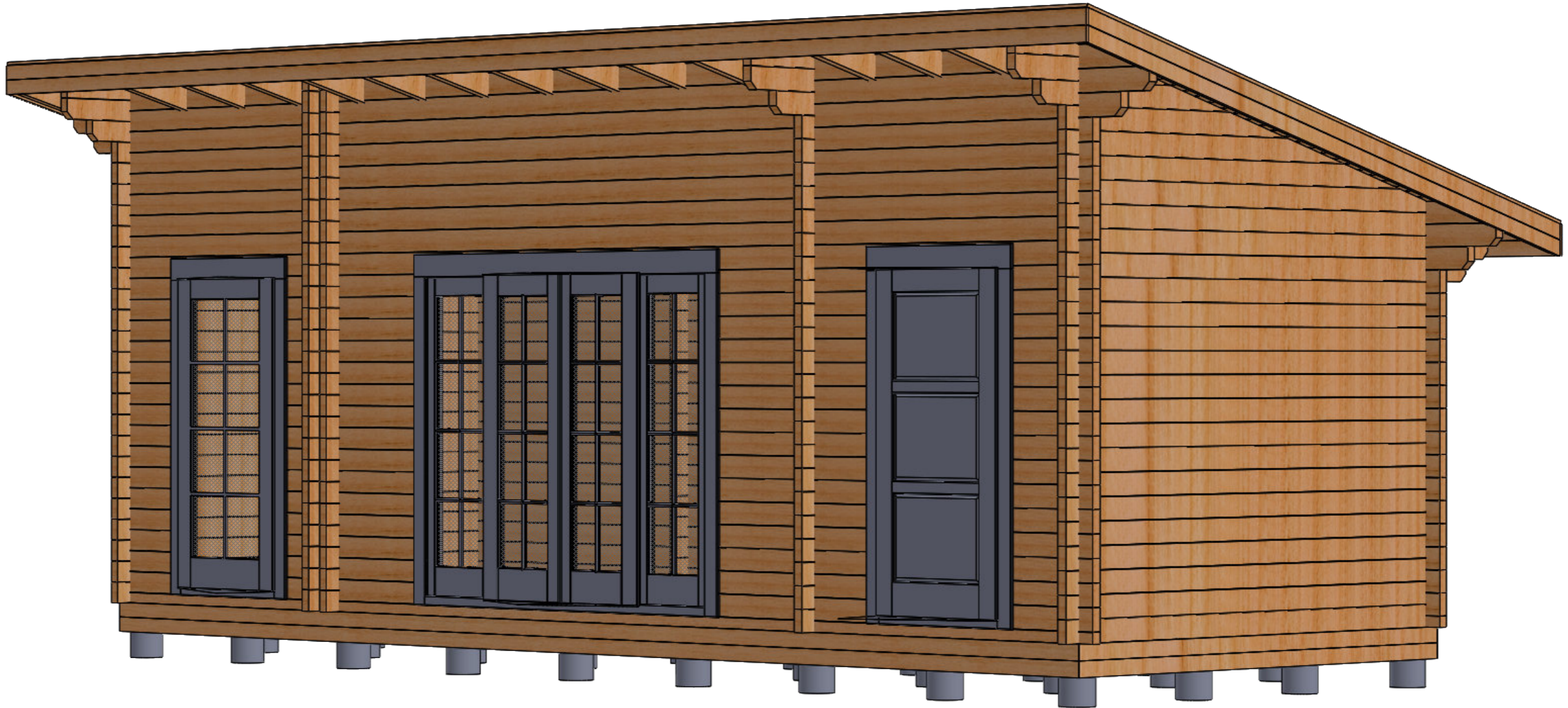
A



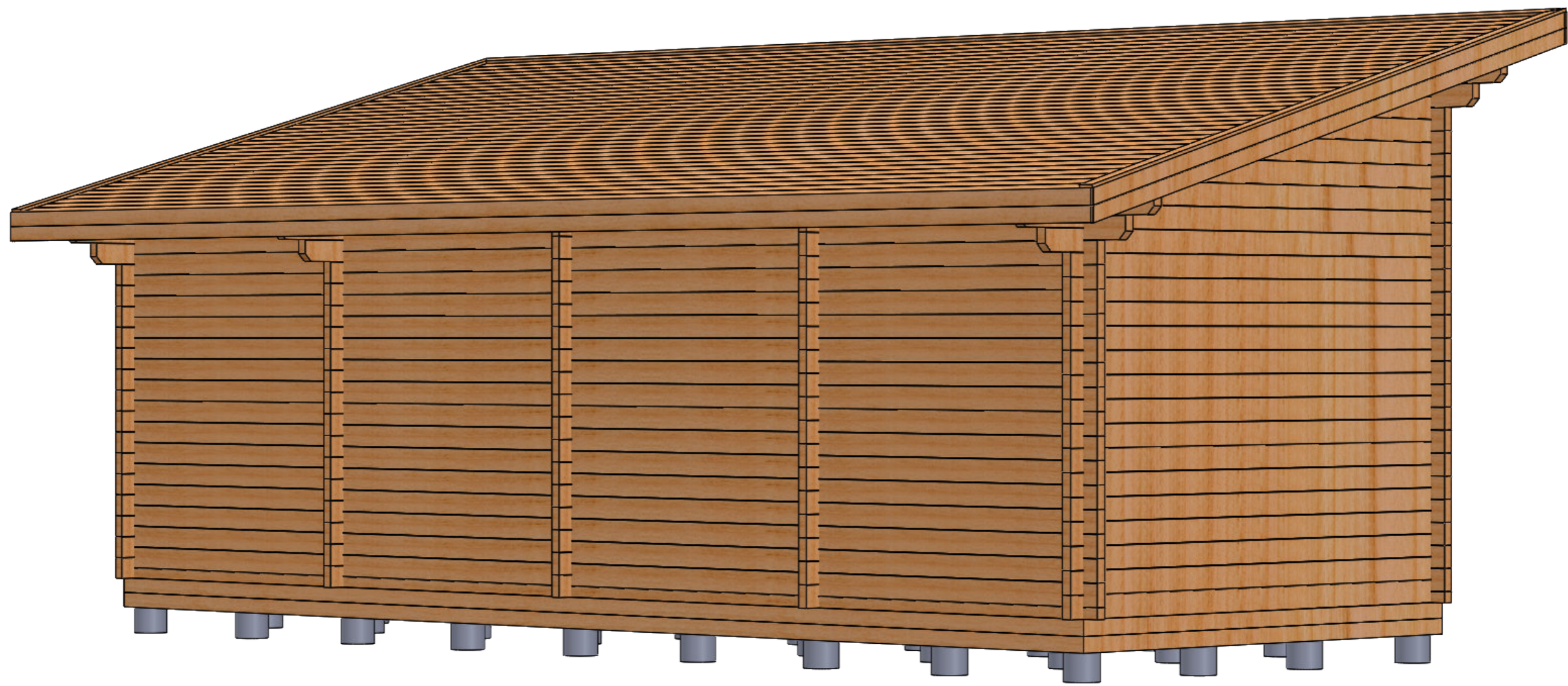

| | |
|------|------------|
| Date | 2026-03-19 |
| | 10:20:54 |

| | | | | | | |
|---|---|-----------|------------|--|------------------|--------|
|   | | | 2026-03-19 | | 20719 NB8030(60) | A3 |
| | G | Sheet 2-9 | Date | | | Sheet2 |



| | |
|------|------------|
| Date | 2026-03-19 |
| | 10:20:54 |

| | | | | | | | |
|---|---|-----------|------|------------|--|------------------|--------|
|   | | | | 2026-03-19 | | 20719 NB8030(60) | A3 |
| | G | Sheet 3-9 | Date | 10:20:54 | | | Sheet3 |

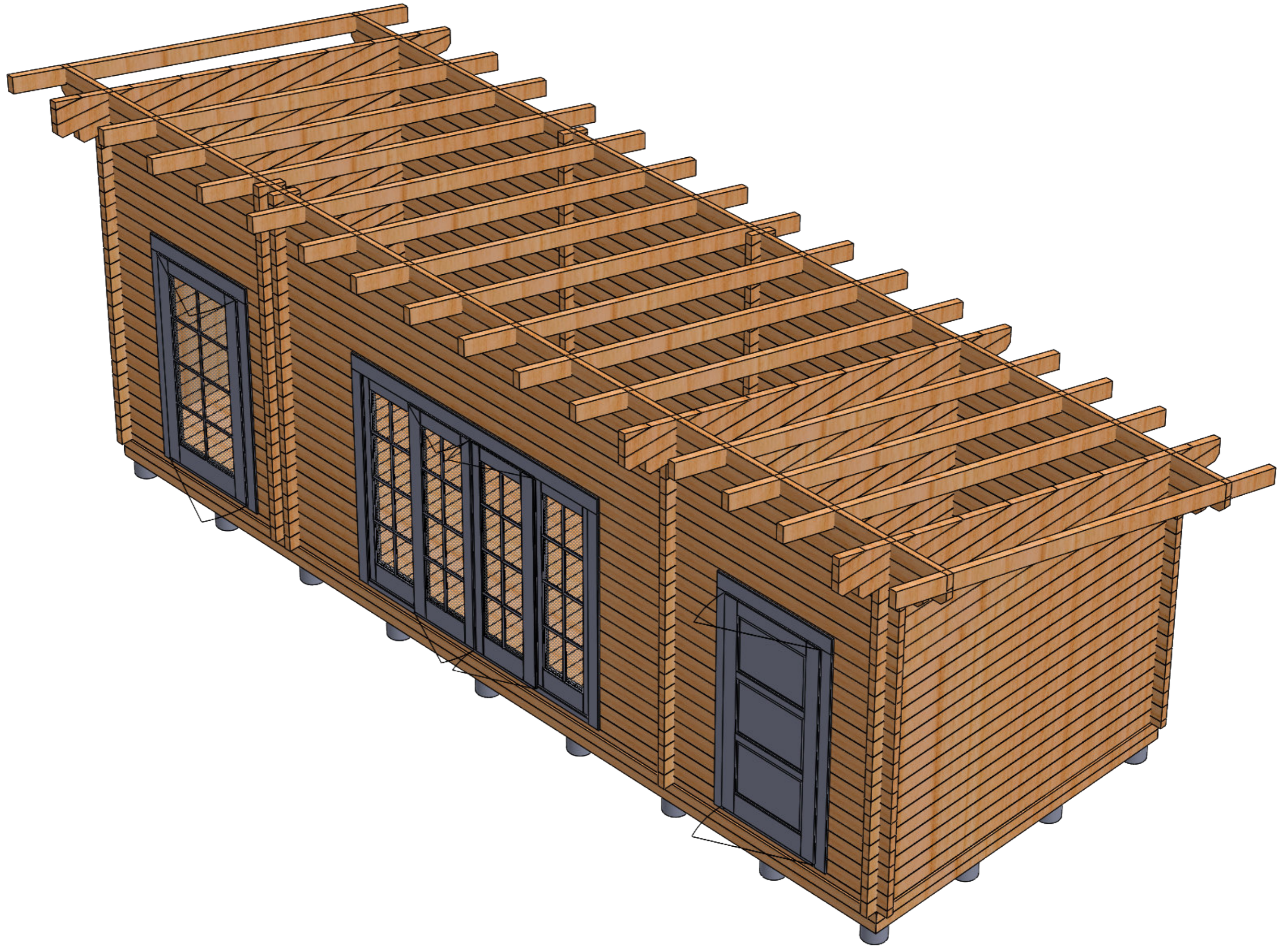

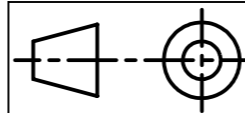

| | |
|------|------------|
| Date | 2026-03-19 |
| | 10:20:54 |

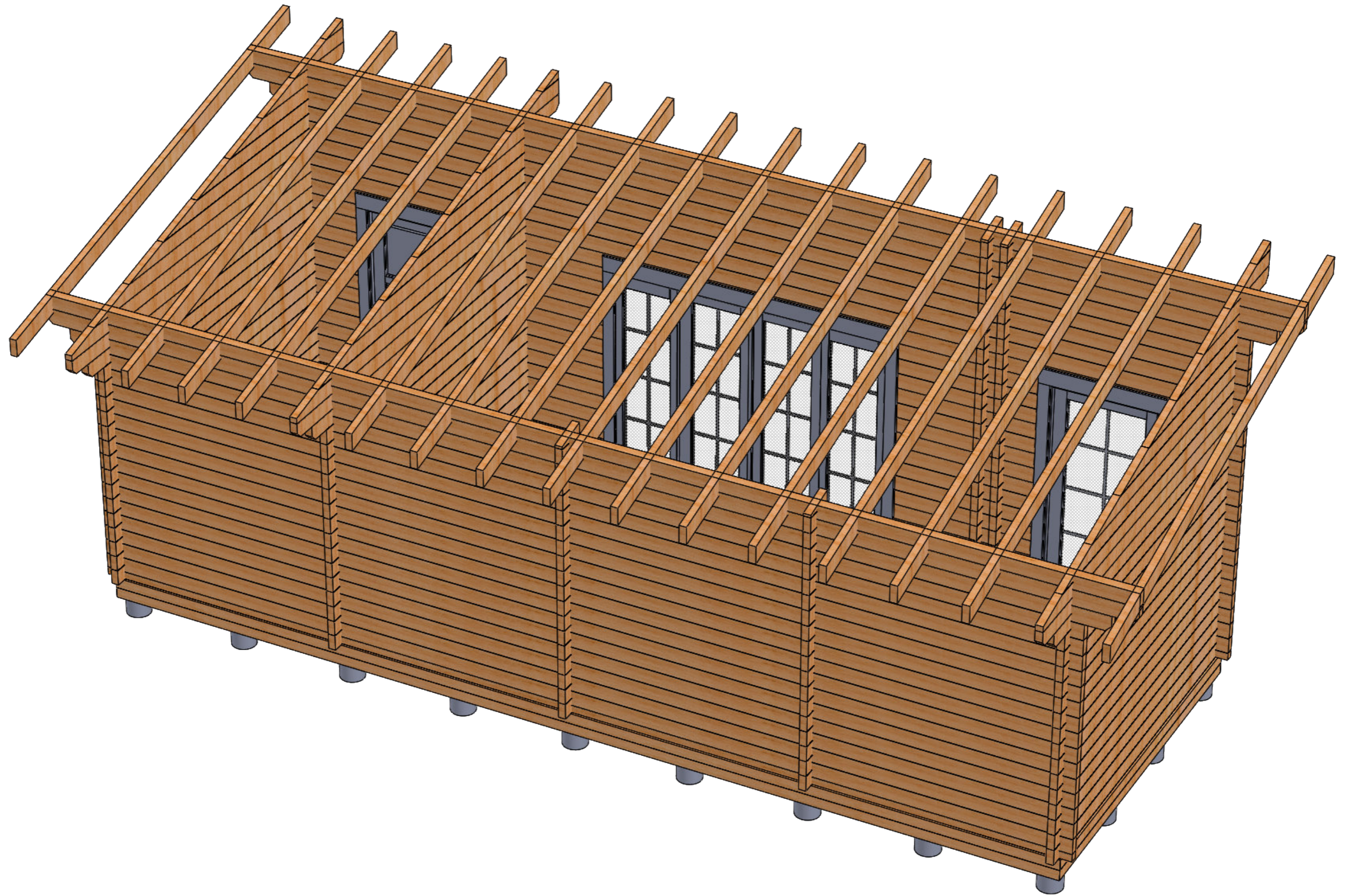

| | | | | |
|---|-----------|------------------------|------------------|--------|
| G | Sheet 4-9 | 2026-03-19 10:20:54 | 20719 NB8030(60) | A3 |
| | | Date | | Sheet4 |



| | |
|------|------------|
| Date | 2026-03-19 |
| | 10:20:54 |

| | | | | | |
|---|---|-----------|------------|------------------|--------|
|   | G | Sheet 5-9 | 2026-03-19 | 20719 NB8030(60) | A3 |
| | | | Date | | Sheet5 |

2

1

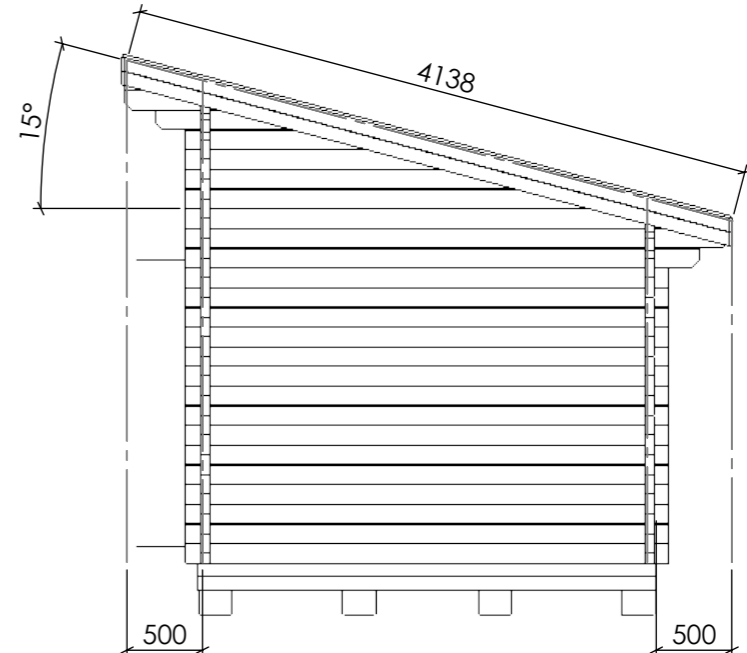
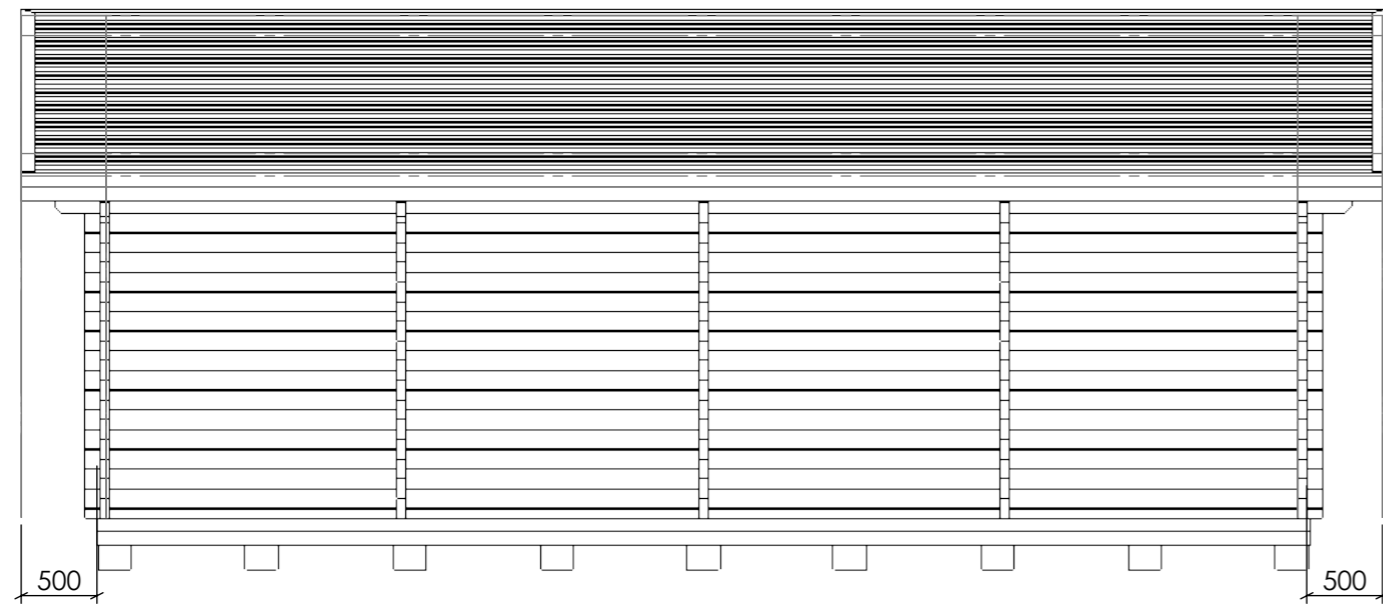
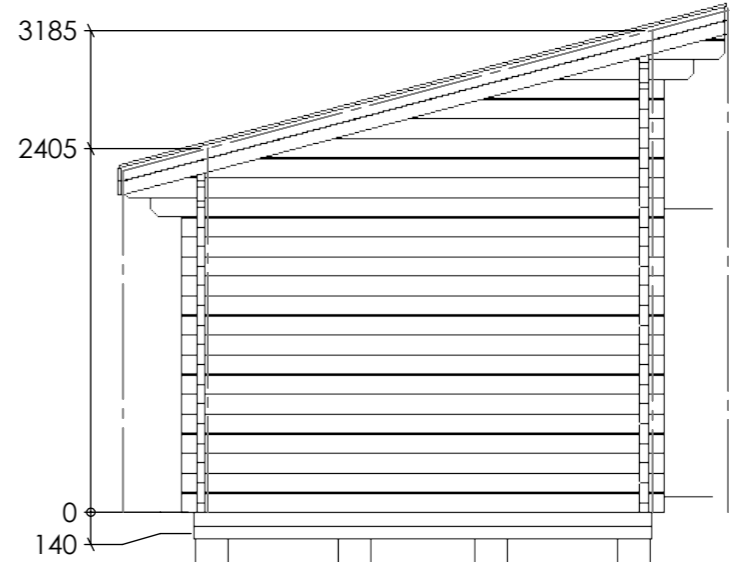
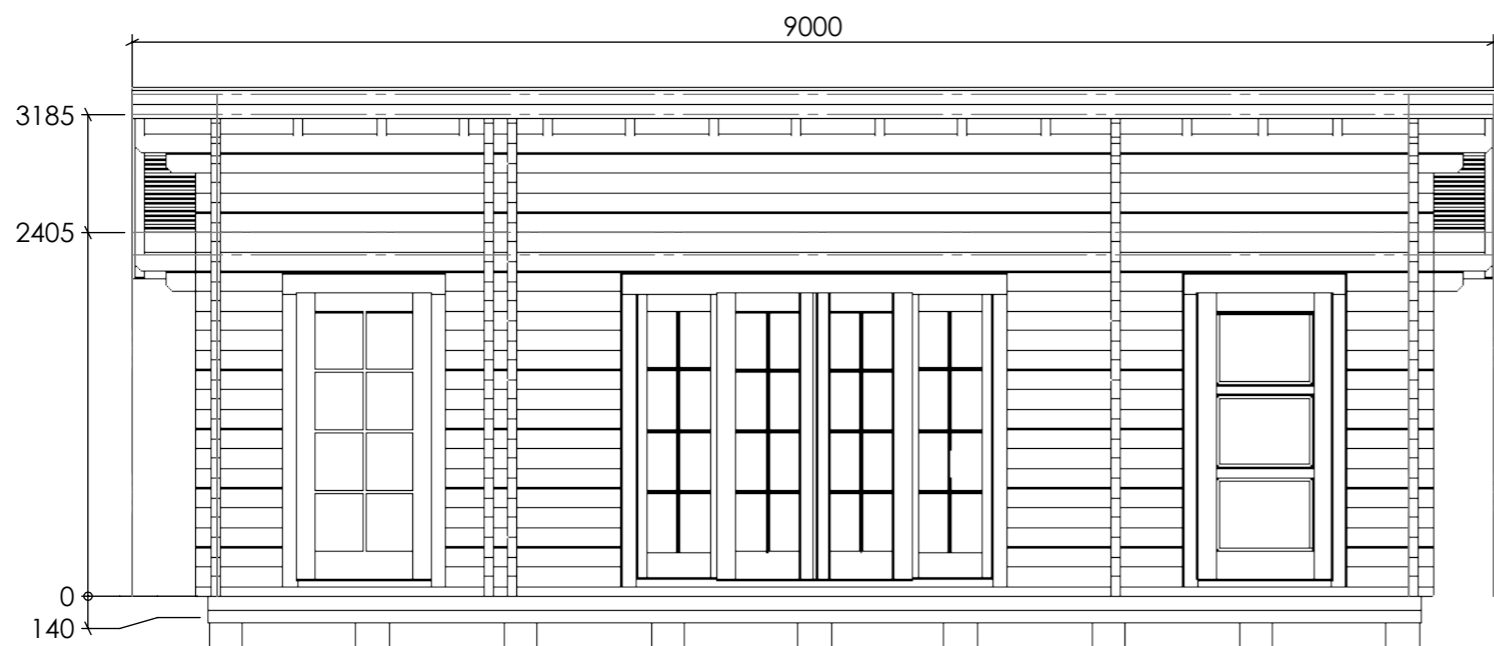

| | |
|------|------------|
| Date | 2026-03-19 |
| | 10:20:54 |

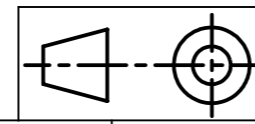

| | | | | | |
|---|-----------|------------|----------|------------------|---------|
| G | Sheet 6-9 | 2026-03-19 | 10:20:54 | 20719 NB8030(60) | A3 |
| | | Date | | | Facades |

2

1

A

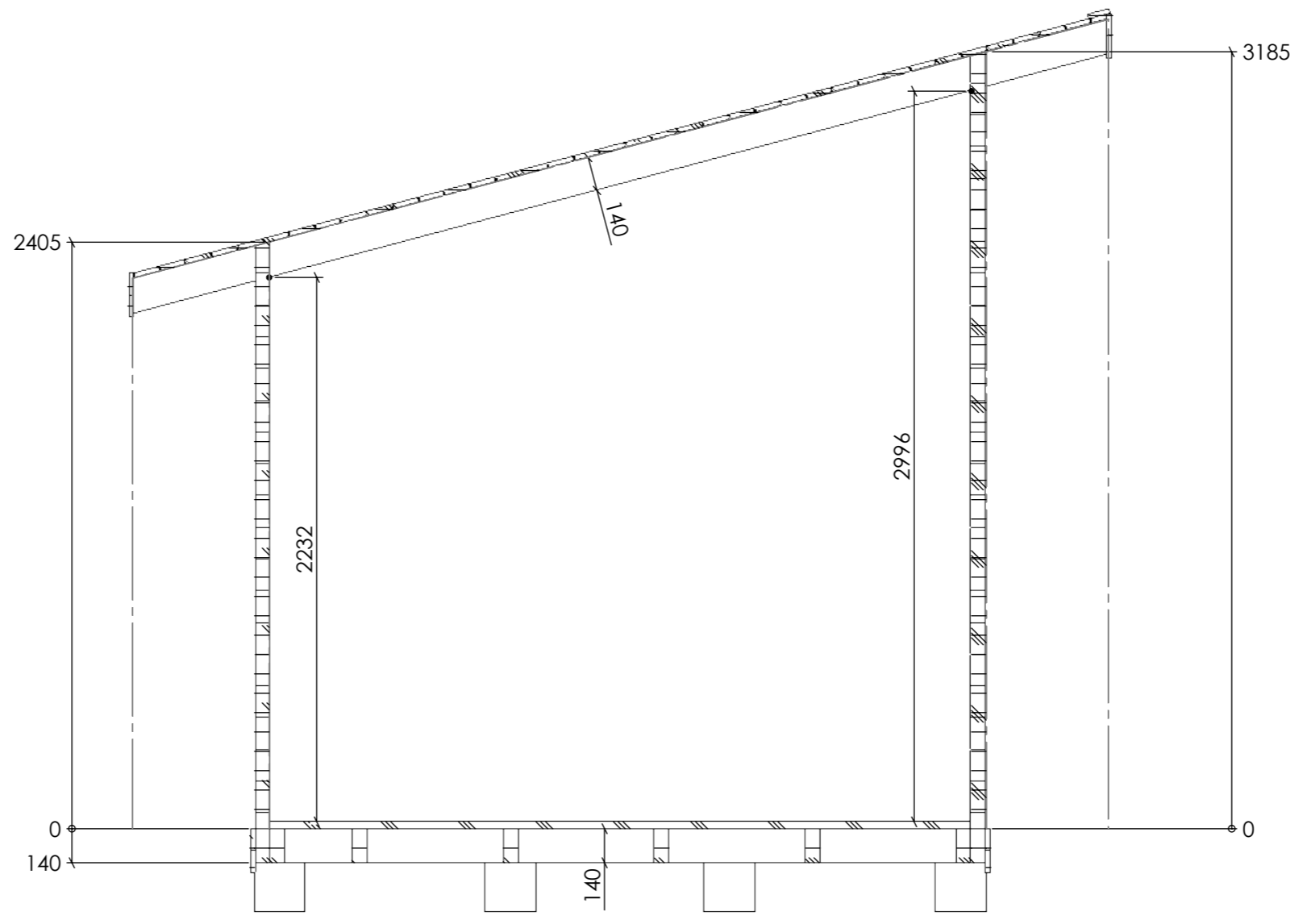

Section

| | |
|------|------------|
| Date | 2026-03-19 |
| | 10:20:54 |
| | |
| | |
| | |

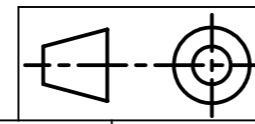

| | | | | |
|---|-----------|------------------------|------------------|---------|
| G | Sheet 7-9 | 2026-03-19 10:20:54 | 20719 NB8030(60) | A3 |
| | | Date | | Section |

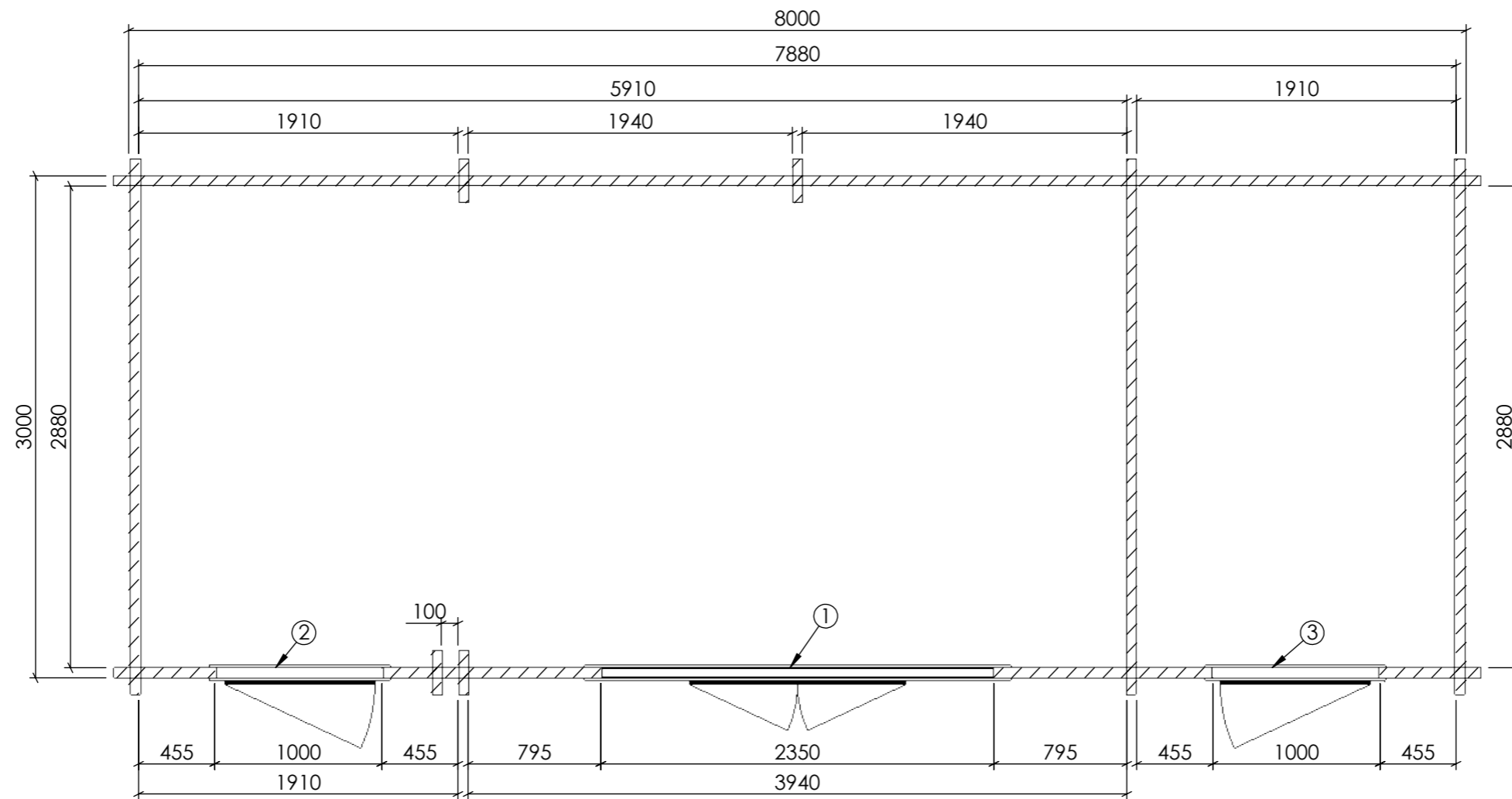

Plan

| | |
|------|---------------------|
| Date | 2026-03-19 10:20:54 |
| 6.90 | |

| ITEM NO. | Element | QTY. |
|----------|----------------|------|
| 1 | Door 1980x2330 | 1 |
| 2 | Door 1980x980 | 1 |
| 3 | Door 1980x980 | 1 |

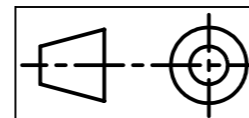

| | | | | |
|---|-----------|---------------------|------------------|------|
| G | Sheet 8-9 | 2026-03-19 10:20:54 | 20719 NB8030(60) | A3 |
| | | Date | | Plan |

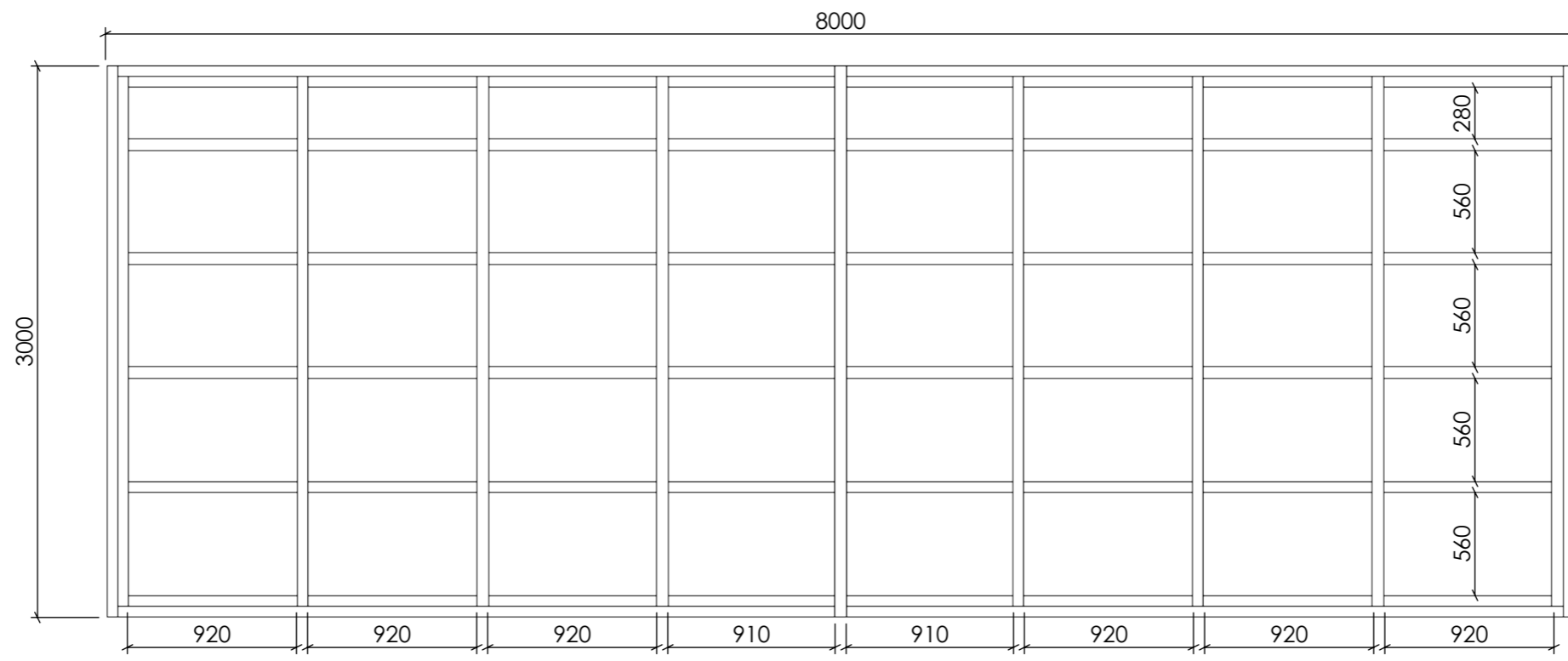

FLOOR BEAMS 60X140

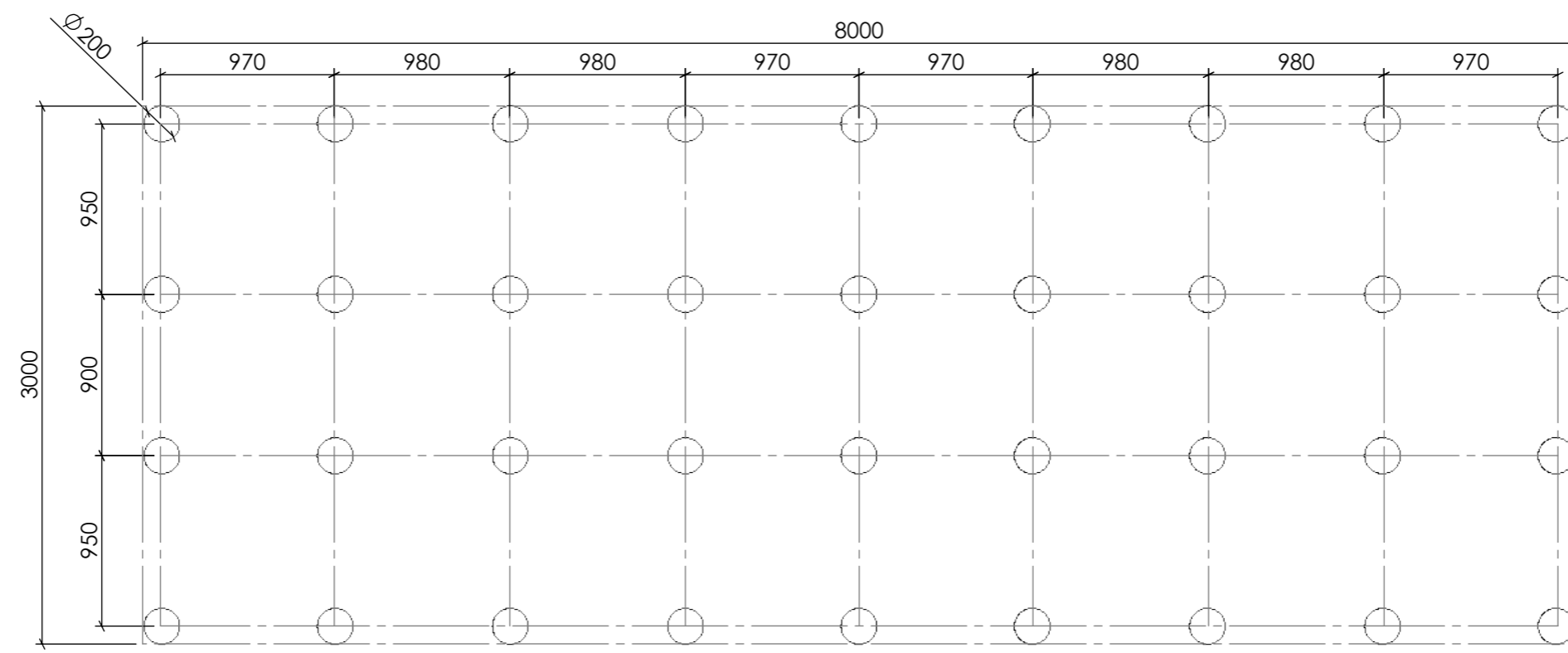

POLE PLAN

| | |
|------|------------|
| Date | 2026-03-19 |
| | 10:20:54 |
| | |
| | |
| | |
| | |

| | | | | | | |
|---|---|-----------|------------------------|------|------------------|-------|
|   | G | Sheet 9-9 | 2026-03-19 10:20:54 | Date | 20719 NB8030(60) | A3 |
| | | | | | | POLES |