

Date	2021-05-07

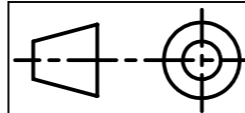

2022-03-21 15:27:45	
Date	

20210 Hugin 30 (44)

1/9	A3
3D	

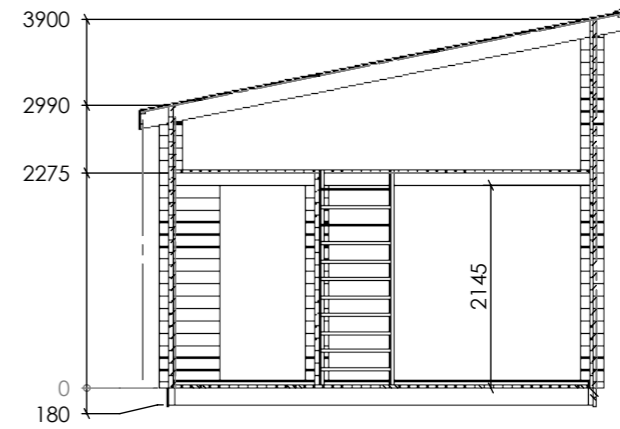
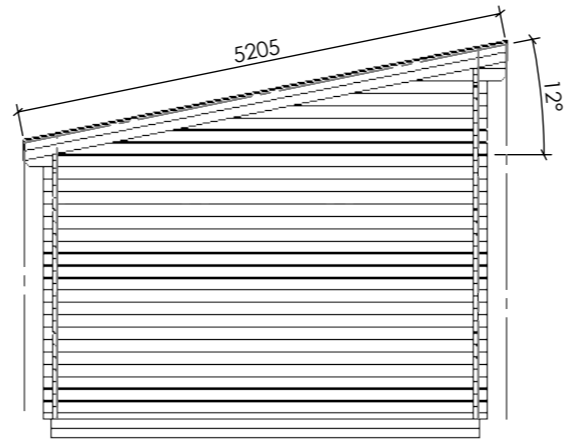
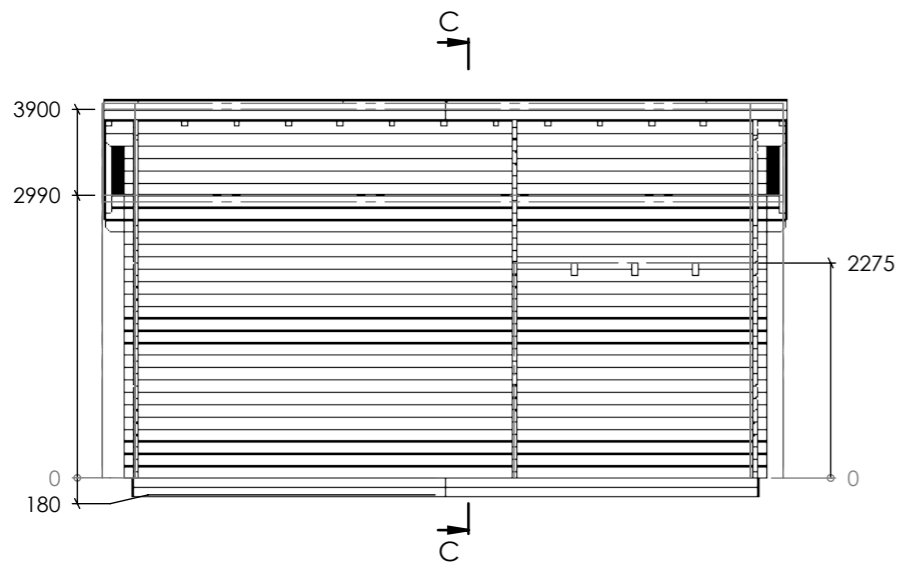

C-C

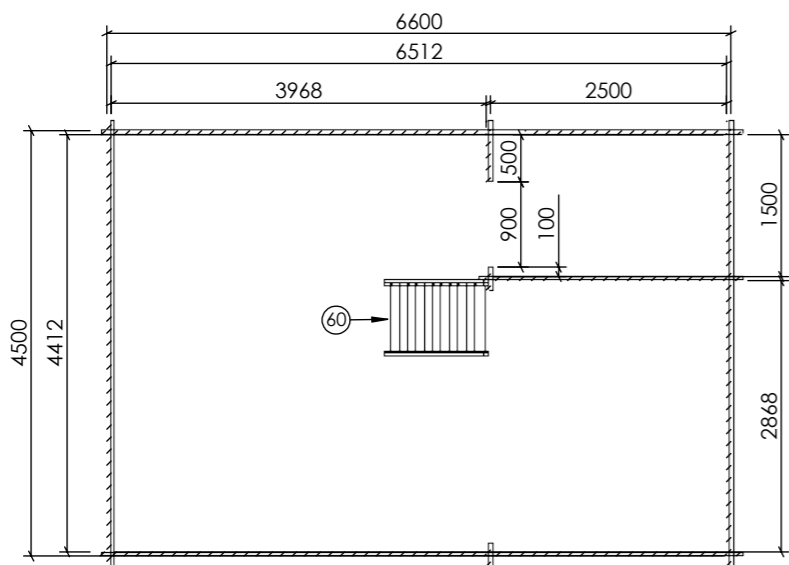
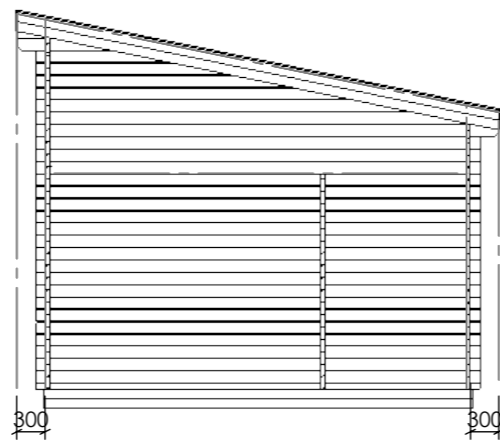
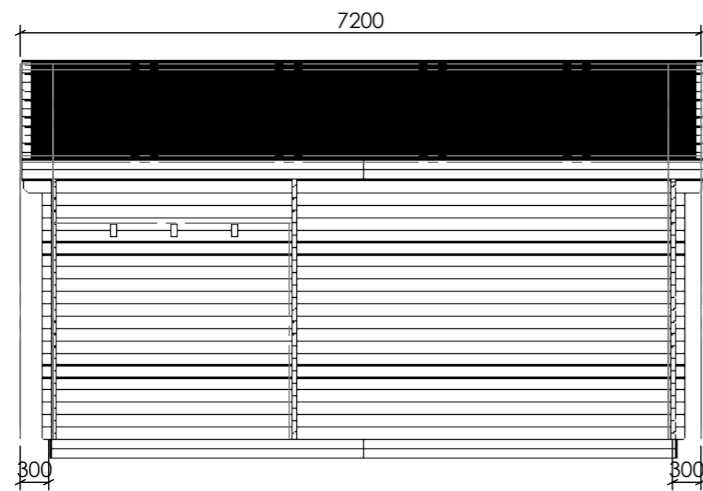

Plan

ITEM NO.	DESCRIPTION	QTY.
60	STAIRS	1

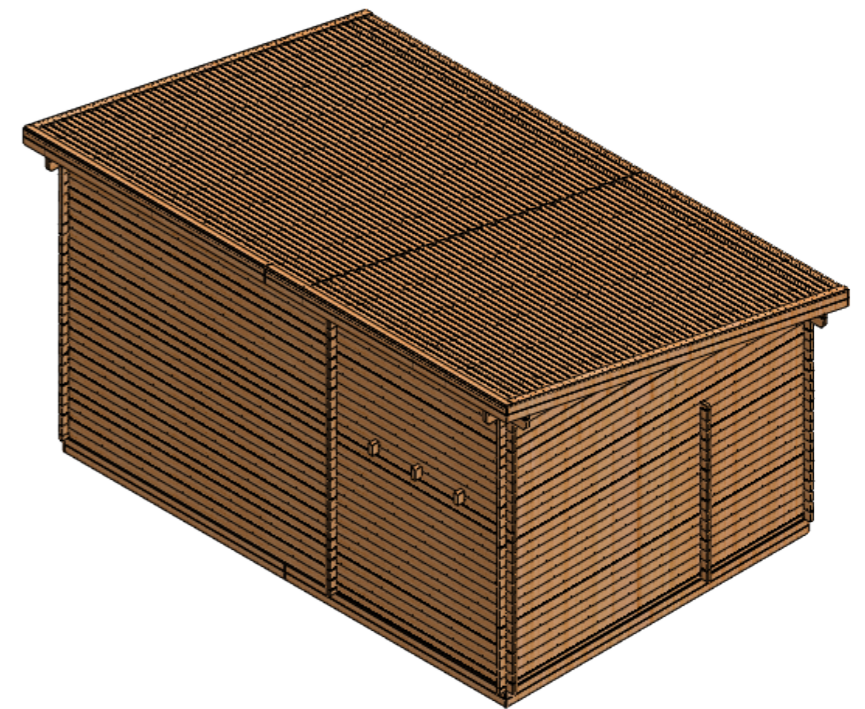

Date	2021-05-07
------	------------

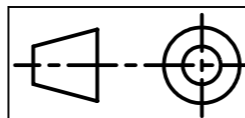

Sheet 2-2

2022-03-21
15:27:45

Date

20210 Hugin 30 (44)

2/9 A3

Plan/Facades

Date	2021-11-15

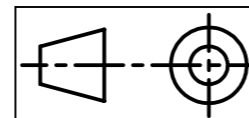
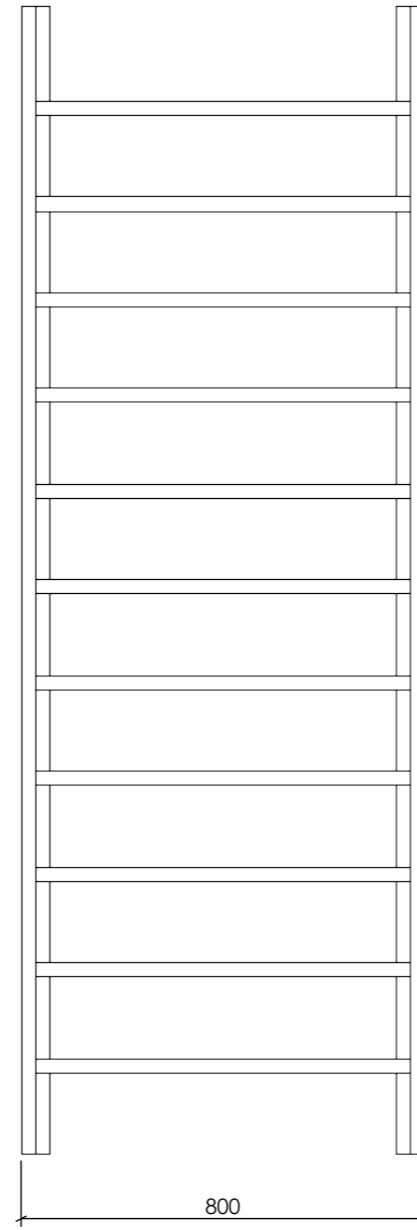
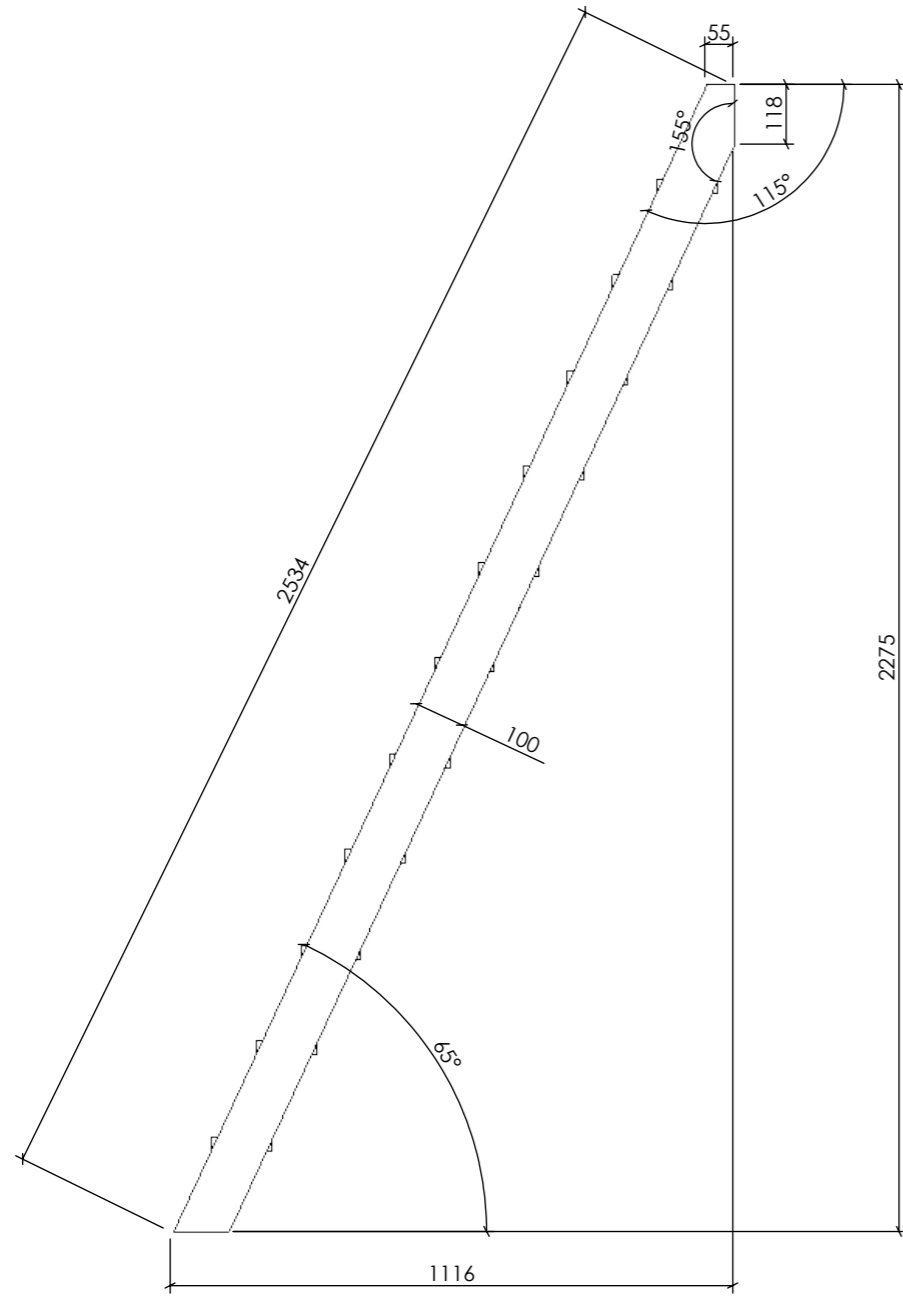

2022-03-21
15:26:18

Date

20210 Hugin 30 (44) [Stairs]

3/9 A3
Stairs

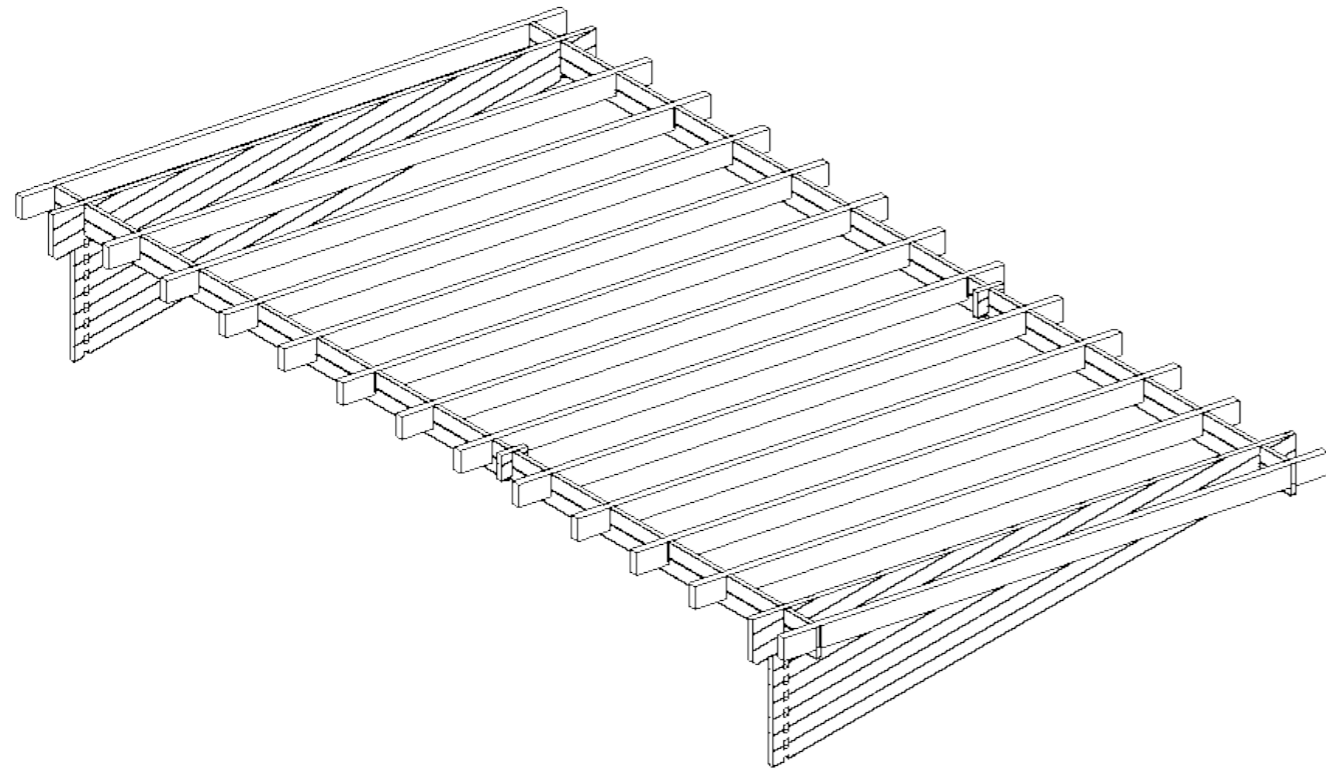

Rafters 60x180

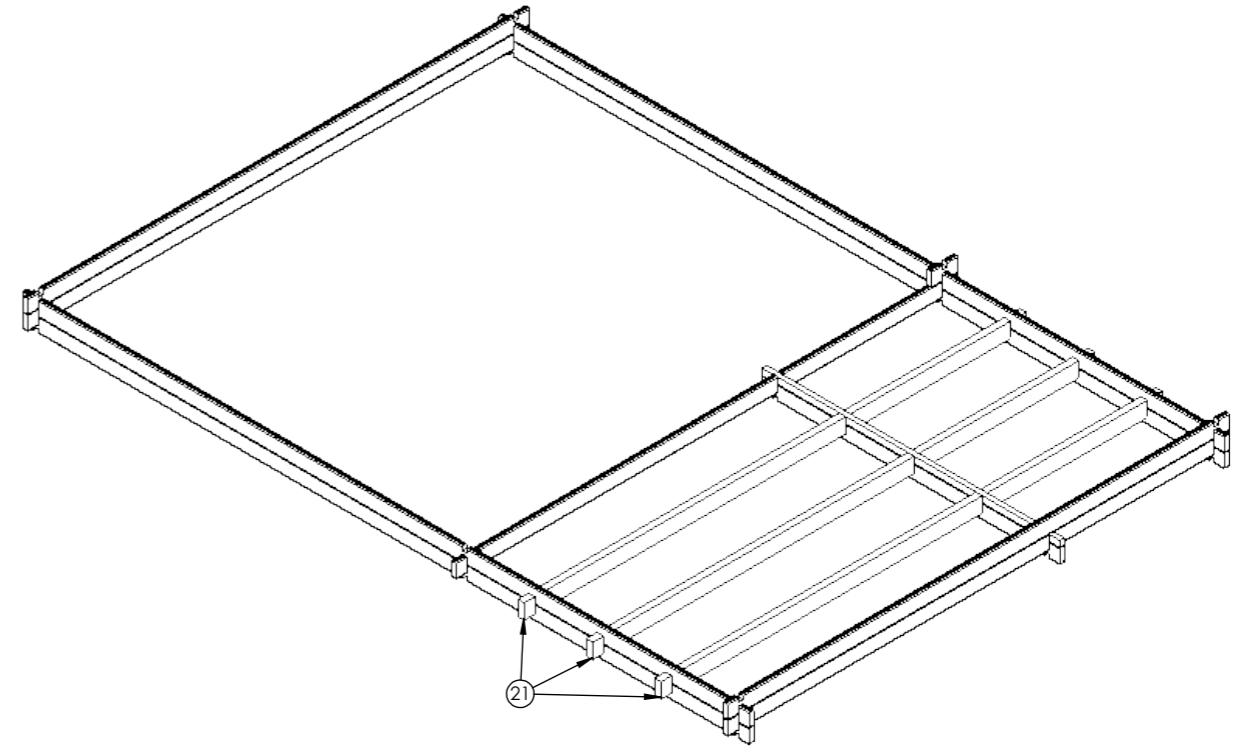

Floor balks 60x140

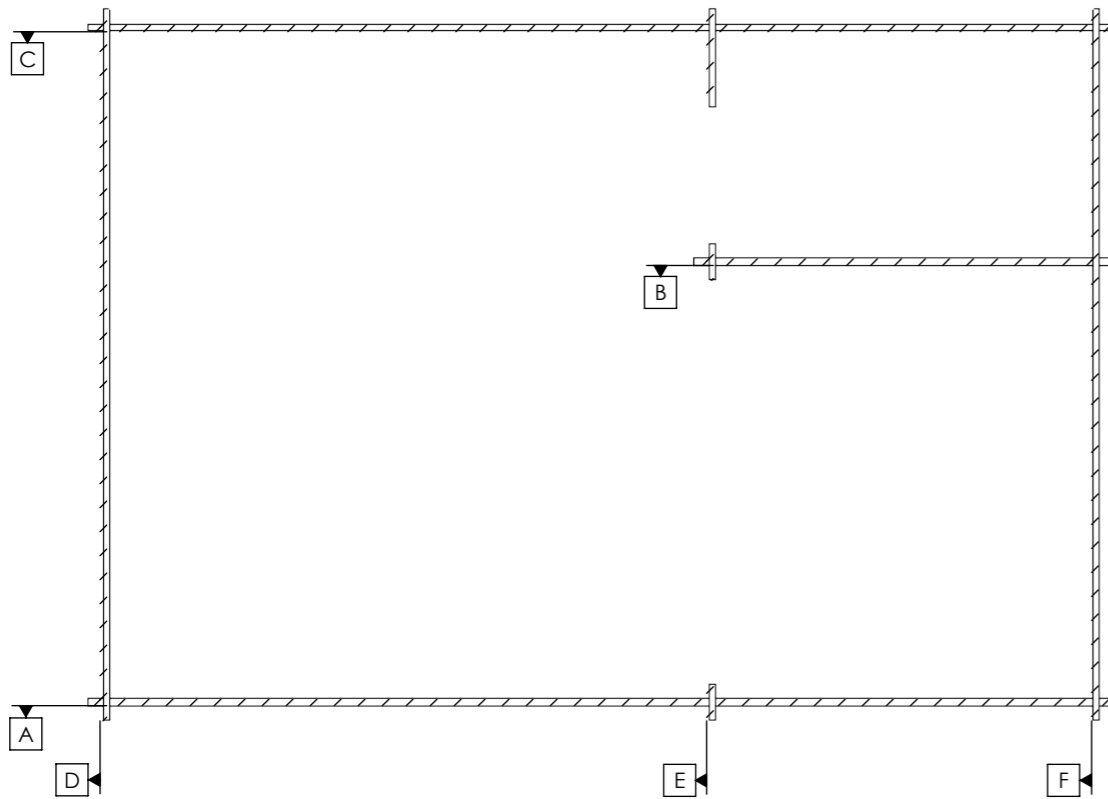

Walls plan

Date	2021-11-12

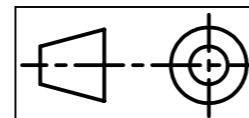

			2022-03-21 15:15:12		20210 Hugin 30 (44) [W]	4/9 A3
	Sheet 1-6	Date				Walls plan

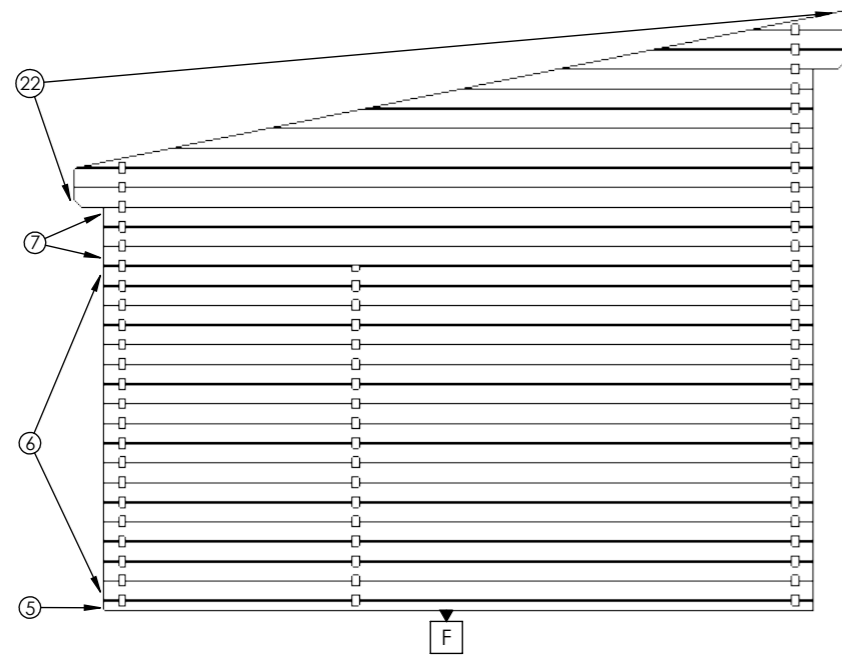
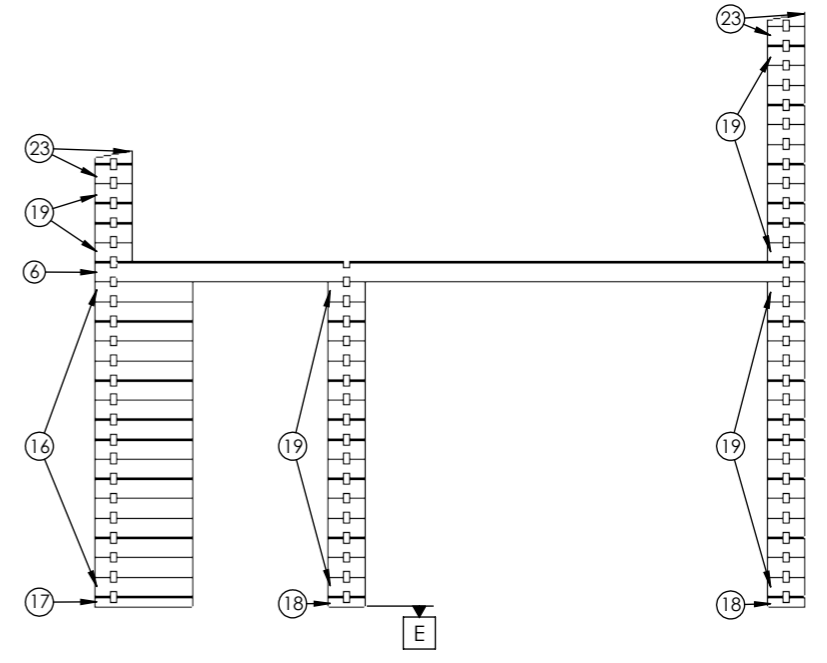
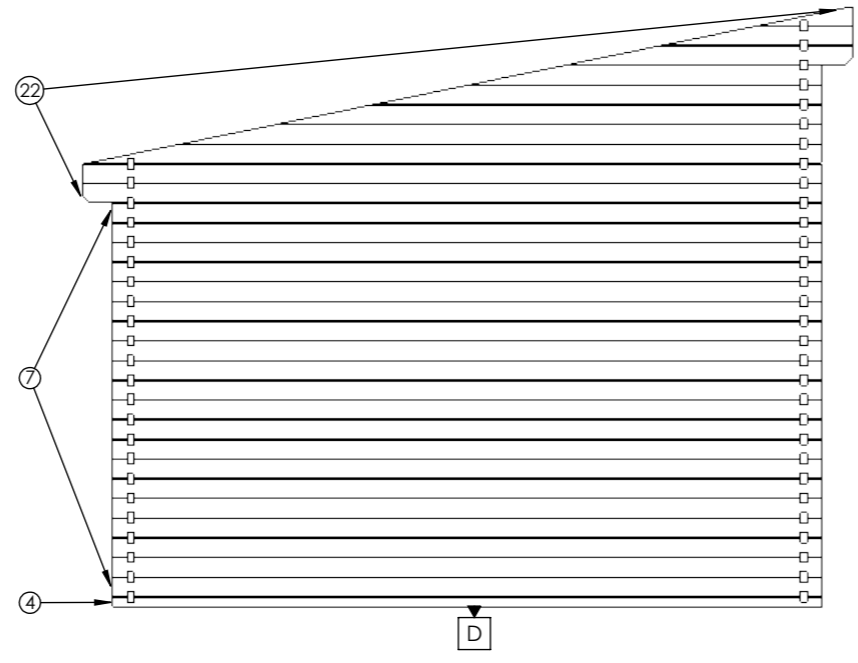
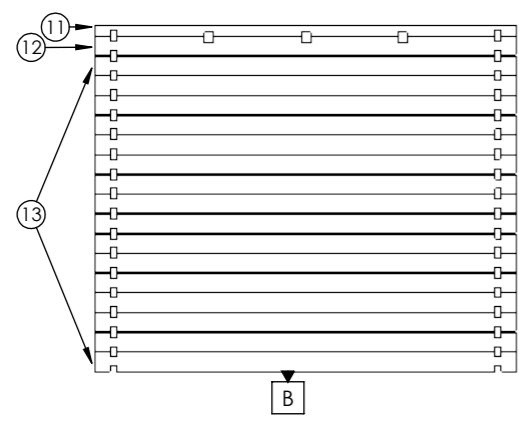
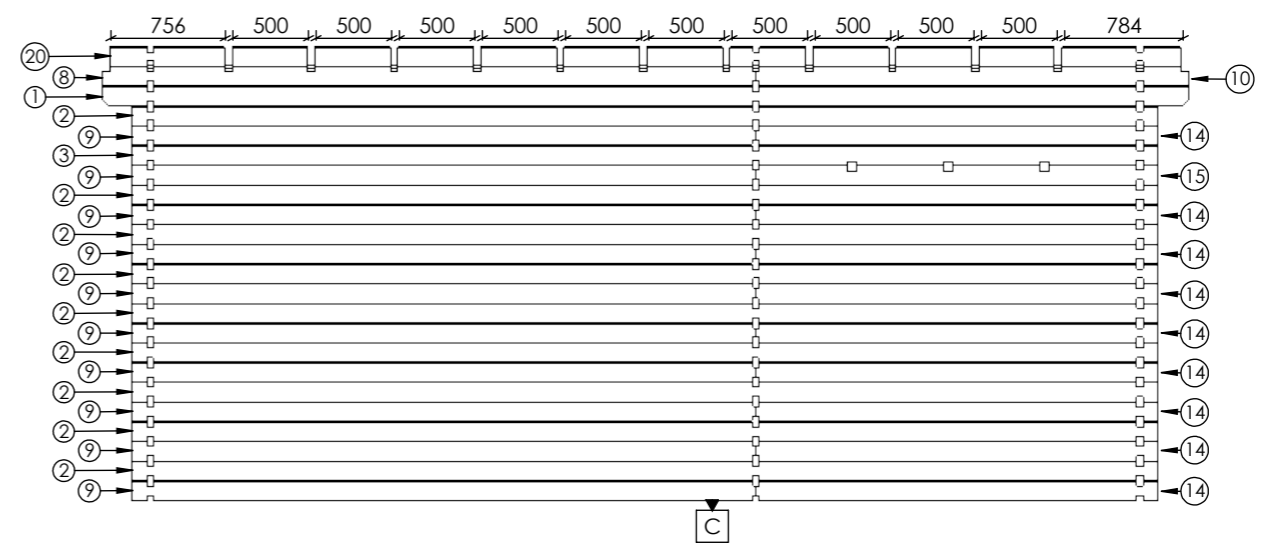
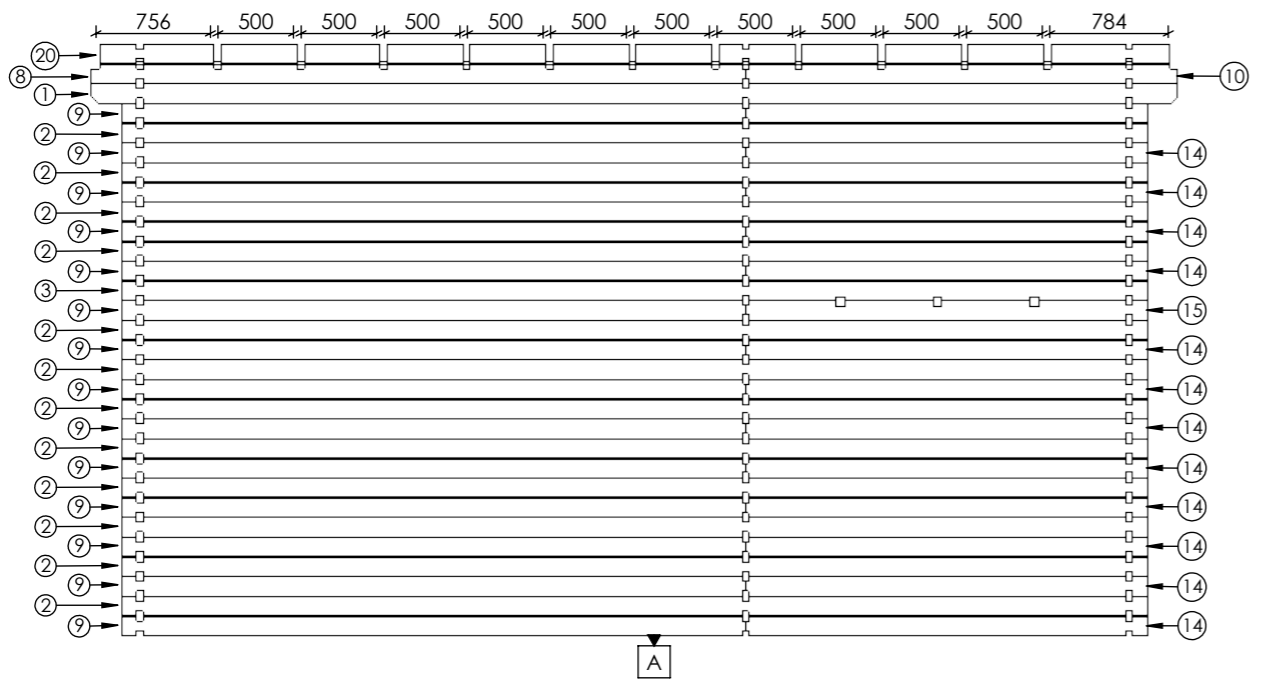

Date	2021-11-12
------	------------

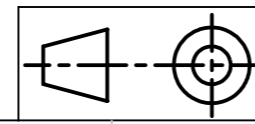

Sheet 2-6	Date	2022-03-21 15:15:12	20210 Hugin 30 (44) [W]	5/9 A3
Walls A;B;C;D;E;F				

ITEM NO.	QTY.	DESCRIPTION	LENGTH
1	2	SIDE BEAM 130x44	7200
2	21	SIDE BEAM 130x44	6800
3	2	SIDE BEAM 130x44	6800
4	1	SIDE BEAM 130x44	4700
5	1	SIDE BEAM 130x44	4700
6	18	SIDE BEAM 130x44	4700
7	23	SIDE BEAM 130x44	4700
8	2	SIDE BEAM 130x44	4333
9	24	SIDE BEAM 130x44	4133
10	2	SIDE BEAM 130x44	2865
11	1	SIDE BEAM 130x44	2788
12	1	SIDE BEAM 130x44	2788
13	16	SIDE BEAM 130x44	2788
14	22	SIDE BEAM 130x44	2665
15	2	SIDE BEAM 130x44	2665
16	16	SIDE BEAM 130x44	644
17	1	SIDE BEAM 130x44	644
18	2	SIDE BEAM 130x44	244
19	47	SIDE BEAM 130x44	244
20	2	SIDE BEAM 130x44	7090
21	3	FLOOR BALKS 140x60	4700
22	2	SIDE BEAM 130x44	5100
23	2	SIDE BEAM 130x44	244

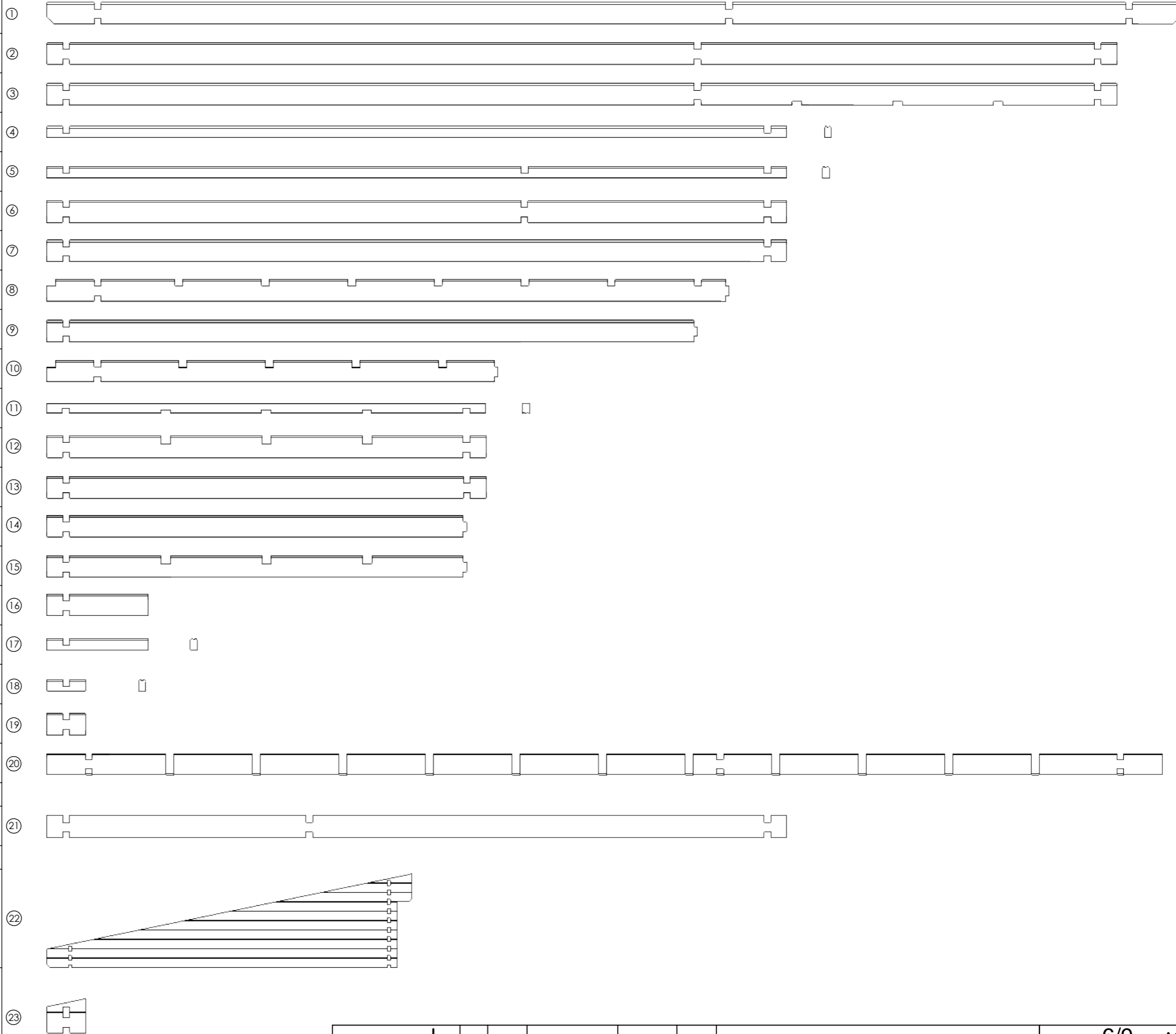

Date
2021-11-12

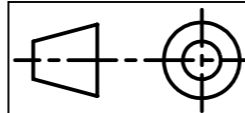

Sheet 3-6

2022-03-21
15:15:12

Date

20210 Hugin 30 (44) [W]

6/9 A3

Pack list 1-23

2

1

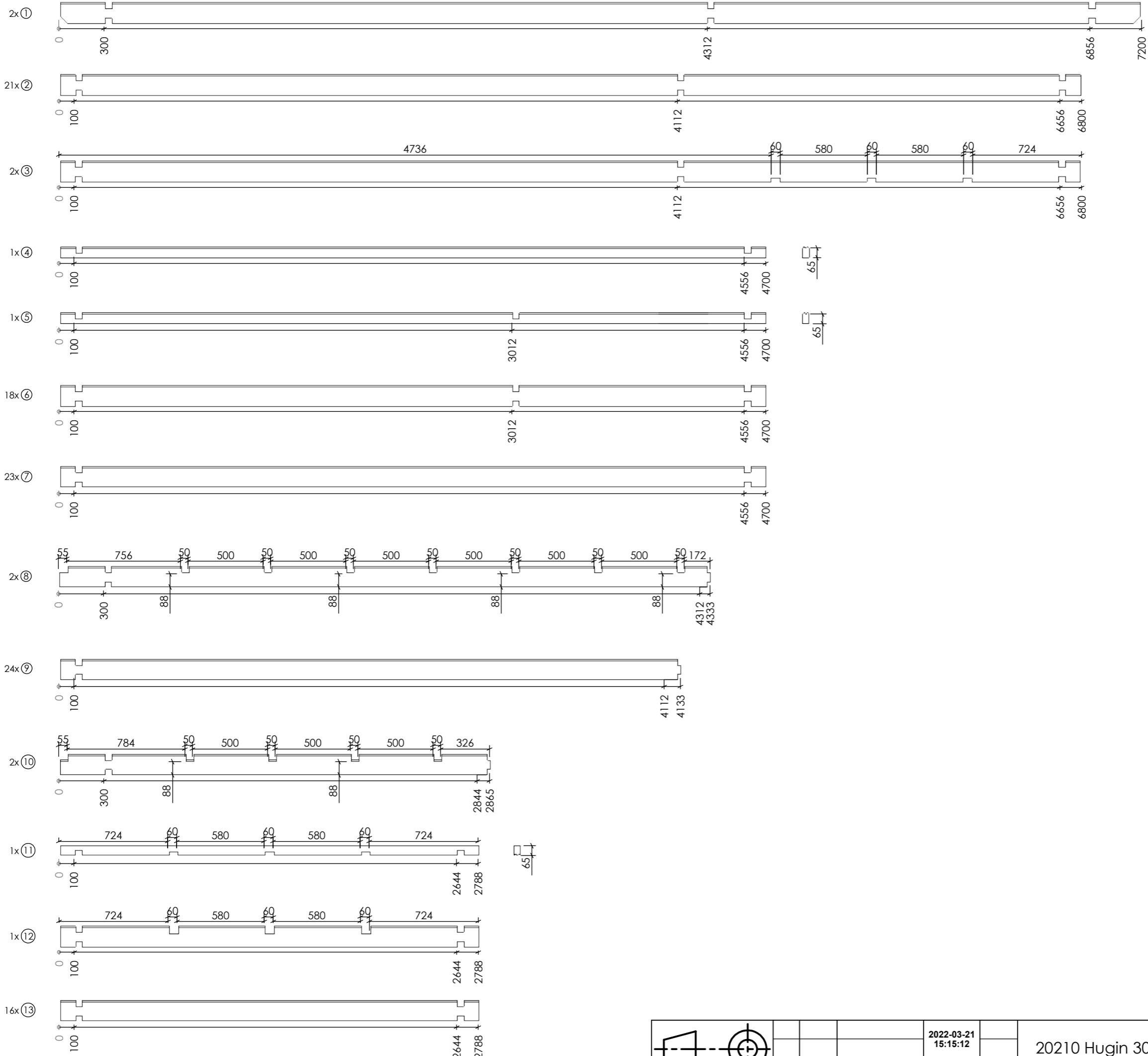

Date	2021-11-12
------	------------

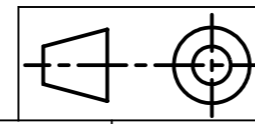

Sheet 4-6

2022-03-21 15:15:12
Date

20210 Hugin 30 (44) [W]

2

1

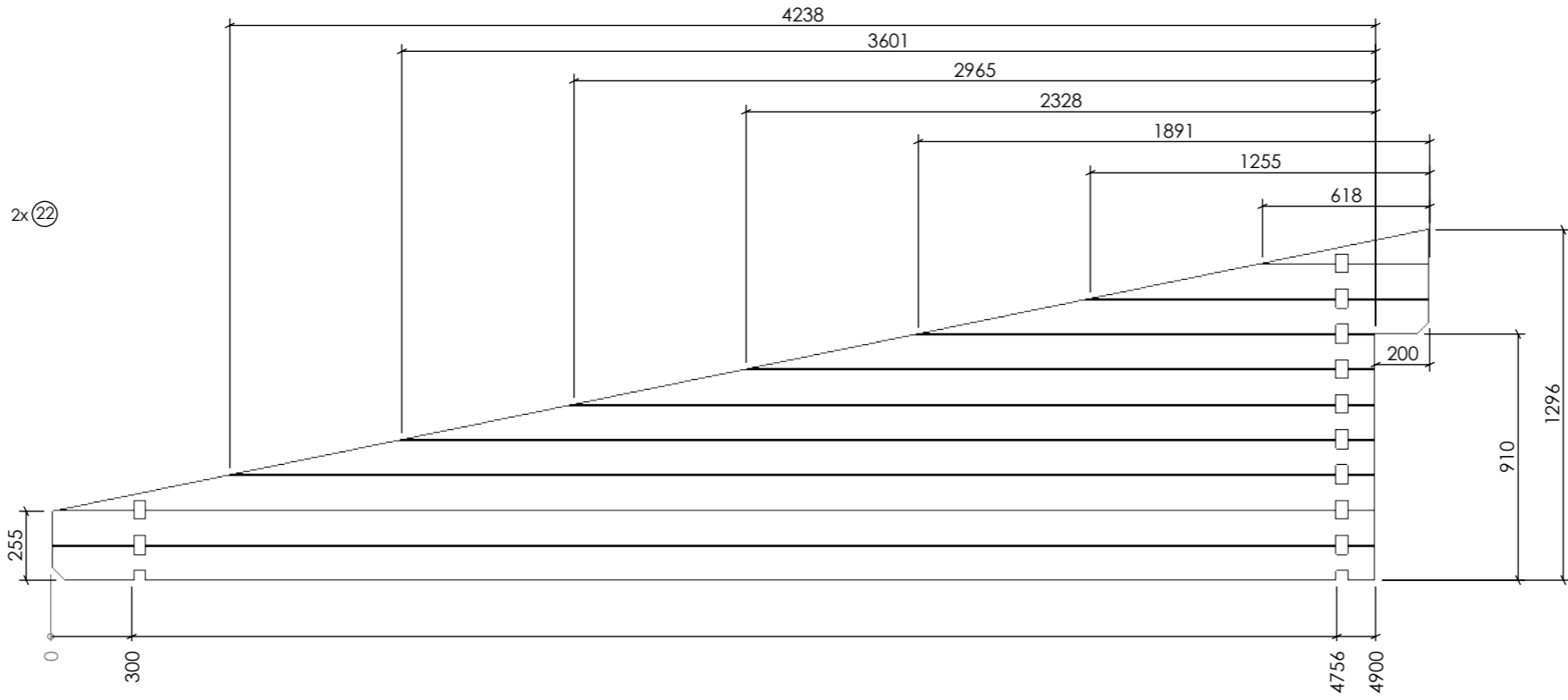

2x (23)

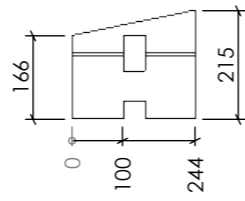

Date	2021-11-12
------	------------

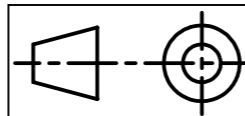

Sheet 6-6

2022-03-21
15:15:12

Date

20210 Hugin 30 (44) [W]

9/9 A3

22-23